

ML-U1628ZR-19C

ML-U-ZR-19 series



Drawing No. A25250

レンズ形式	Lens Type	CCTV Lens	
フォーカス位置	Focus Position	Reference Magnification	M.O.D
光学倍率	Magnification	0.032	0.134
焦点距離 (mm)	Focal Length	16.37	15.46
Fno	Fno	2.80~16.00	
使用波長域 (nm)	Wavelength range used	450~850	
NA	Numerical Aperture	-	-
WD/OD (mm)	Working/Object Distance	500.0 / 503.5	100.0 / 103.5
O/I (mm)	Object to Image Distance	586.49	186.49
鏡筒長 (mm)	Mechanical Tube Length	69.00	
レンズバック (mm)	Lens Back	13.61	13.61
被写界深度 (mm)	DOF @PCoC ϕ 0.04mm	230.128	12.919
分解能 (μ m)	Resolution @ λ =550nm	-	-
前側/後側主点位置 (mm)	Front/Rear Principal Position	28.41 / -3.25	27.63 / -3.77
入射/出射瞳位置 (mm)	Entrance/Exit Pupil Position	17.32 / -37.64	17.01 / -37.64
入射/出射瞳径 (mm)	Entrance/Exit Pupil Diameter	5.81 / 18.03	5.65 / 18.03
画角 (deg.) H×V	Angle Of View	51.16 x 39.17	52.40 x 40.09
TVディストーション (%)	TV Distortion	-0.984	-1.157
周辺光量比 (%)	Relative Illumination	51.77	56.17
質量 (g)	Weight	206.8	
マウント	Mount	C Mount	
イメージサークル径 (mm)	Image Circle	ϕ 19.3	
最大適合カメラ	Largest Compatible Camera	1.2 Inch	

ML-U1628ZR-19C

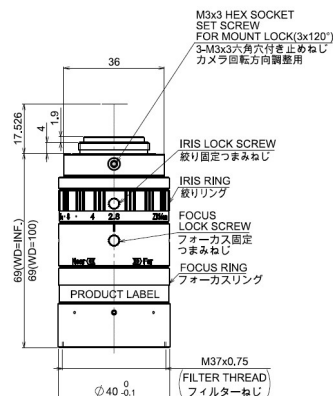

WD=500.0mm Fno2.8

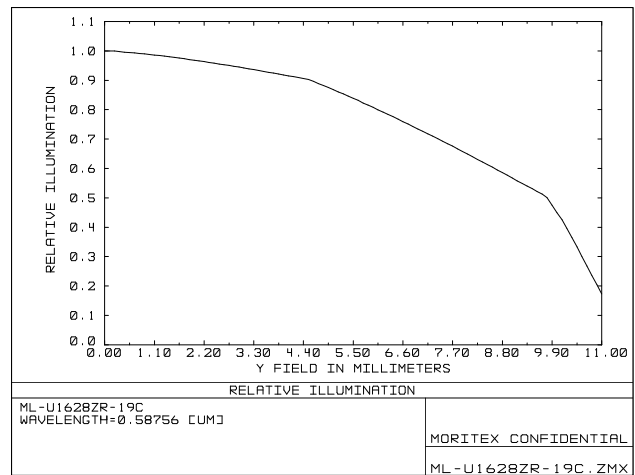
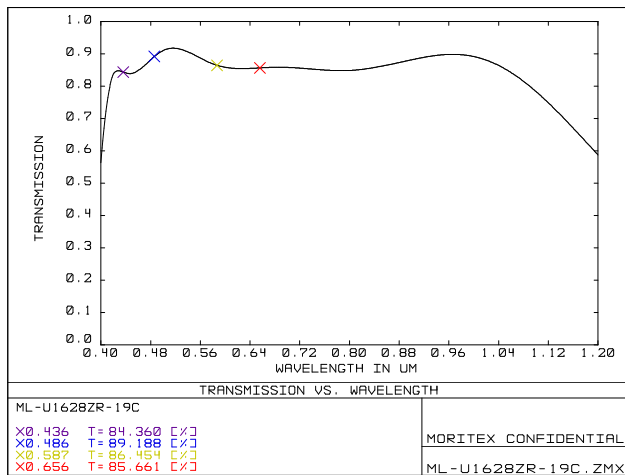
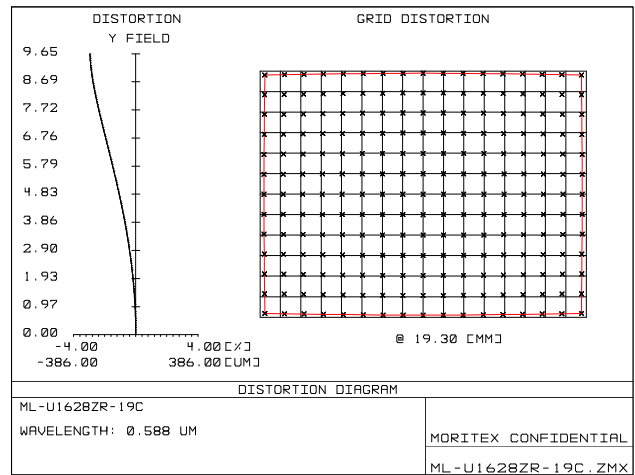
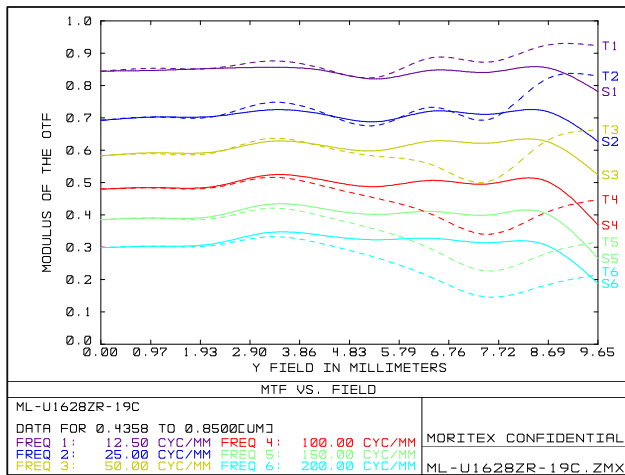

内容は、通知なしに随時変更されることがあります。

The content is subject to change at any time without notification.

株式会社 **モリテックス** MORITEX Corporation

Technology center Lens design & Development technology

moritex.mvs@moritex.com

www.moritex.com



WD=100.0mm Fno2.8

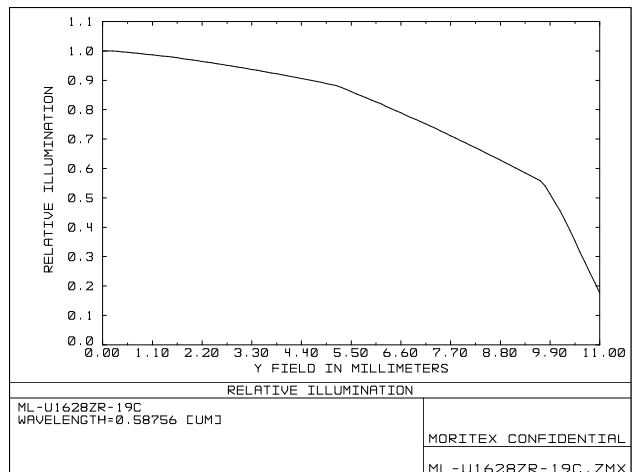
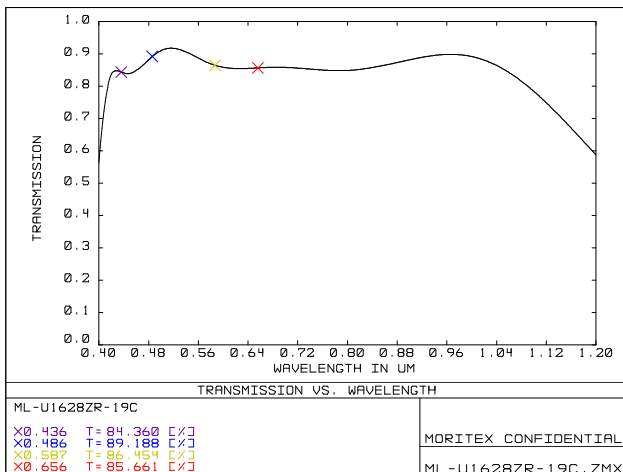
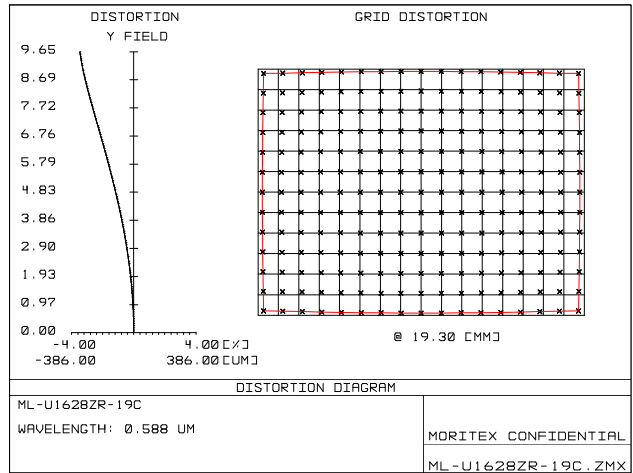
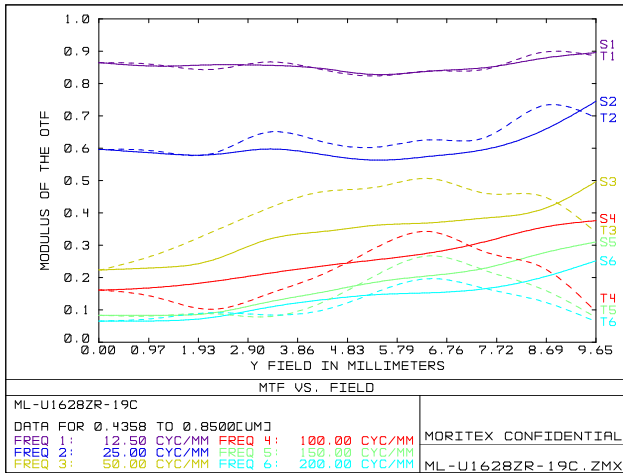

内容は、通知なしに随時変更されることがあります。
 The content is subject to change at any time without notification.

株式会社 **モリテックス** MORITEX Corporation

Technology center Lens design & Development technology
 moritex.mvs@moritex.com
 www.moritex.com



WD=Infinity Fno2.8

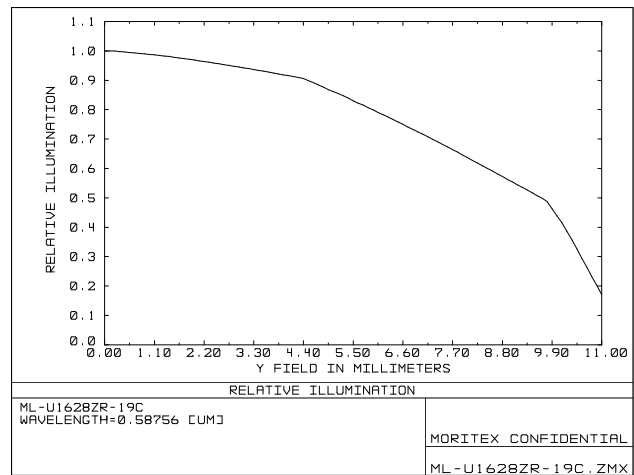
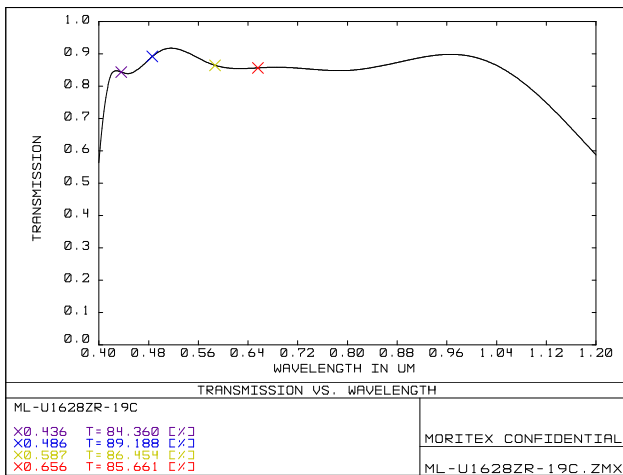
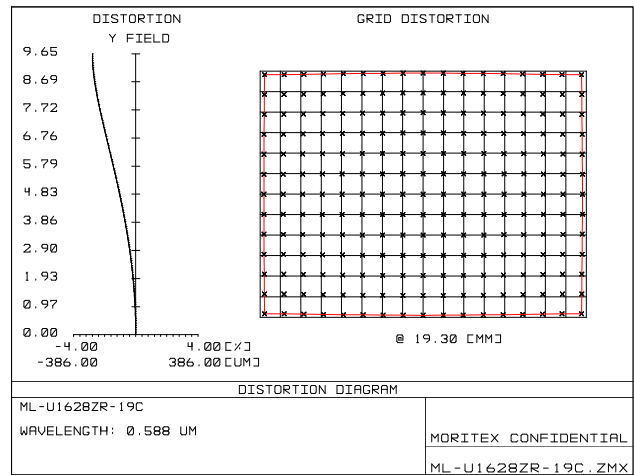
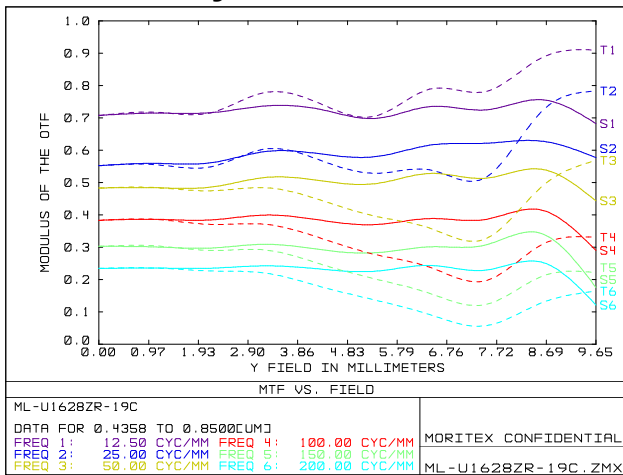

内容は、通知なしに随時変更されることがあります。

The content is subject to change at any time without notification.

株式会社 **モリテックス** MORITEX Corporation

Technology center Lens design & Development technology

moritex.mvs@moritex.com

www.moritex.com



WD=500.0mm Fno3.8

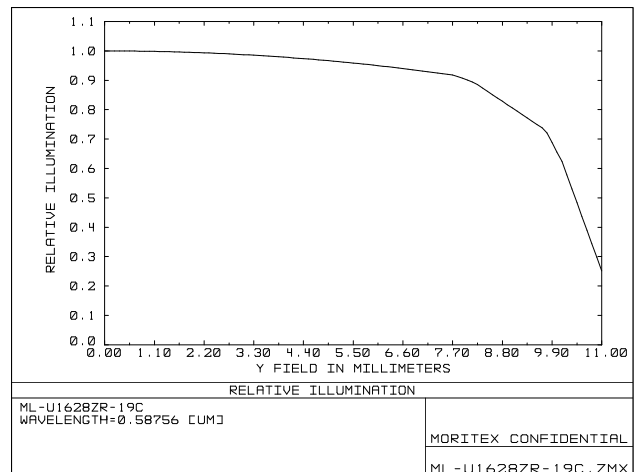
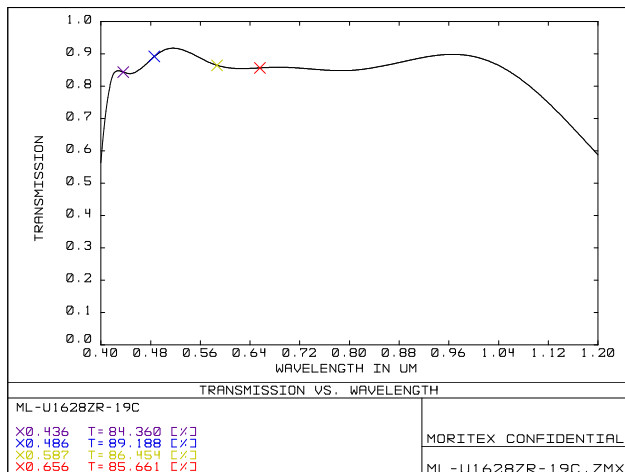
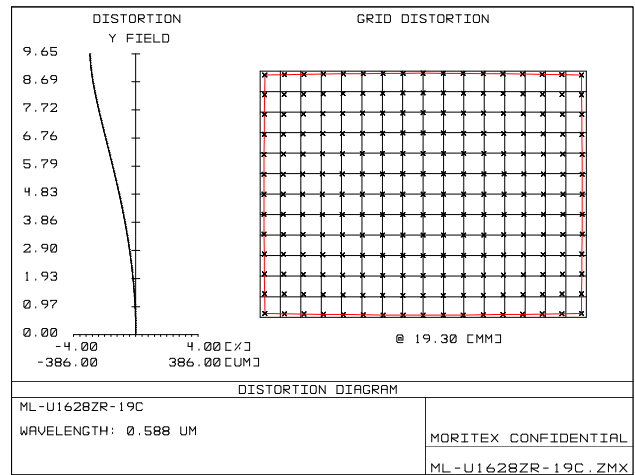
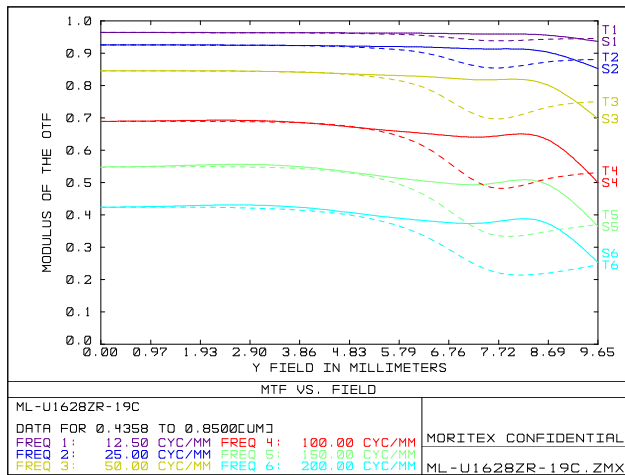

内容は、通知なしに随時変更されることがあります。

The content is subject to change at any time without notification.

株式会社 **モリテックス** MORITEX Corporation

Technology center Lens design & Development technology

moritex.mvs@moritex.com

www.moritex.com



WD=100.0mm Fno3.8

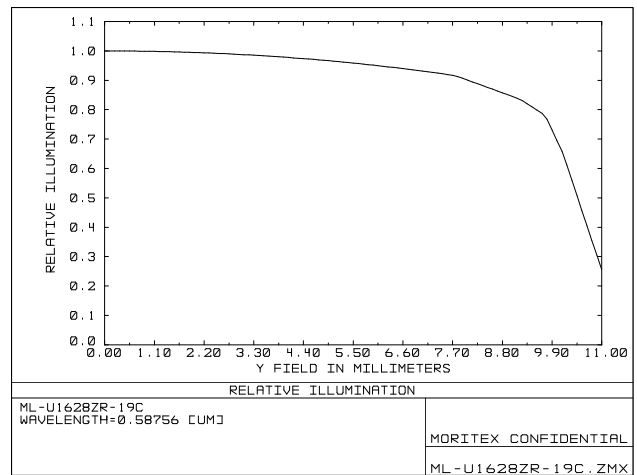
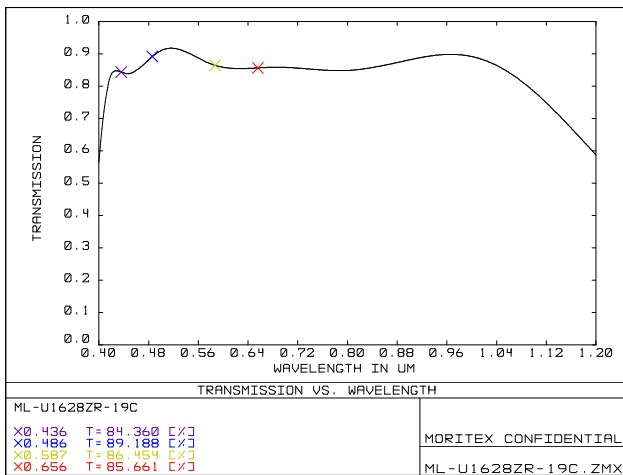
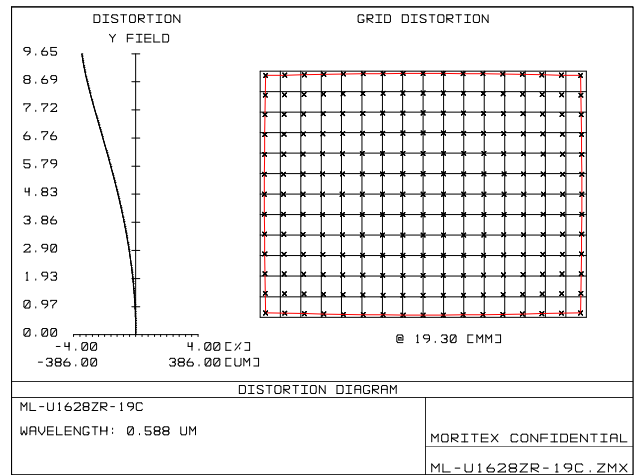
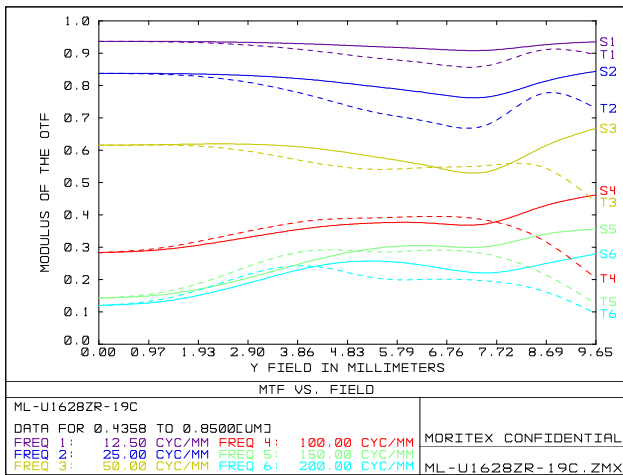

内容は、通知なしに随時変更されることがあります。

The content is subject to change at any time without notification.

株式会社 **モリテックス** MORITEX Corporation

Technology center Lens design & Development technology

moritex.mvs@moritex.com

www.moritex.com



WD=Infinity Fno3.8

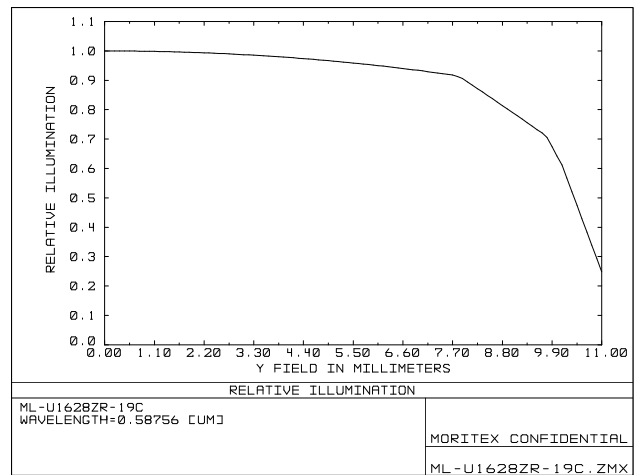
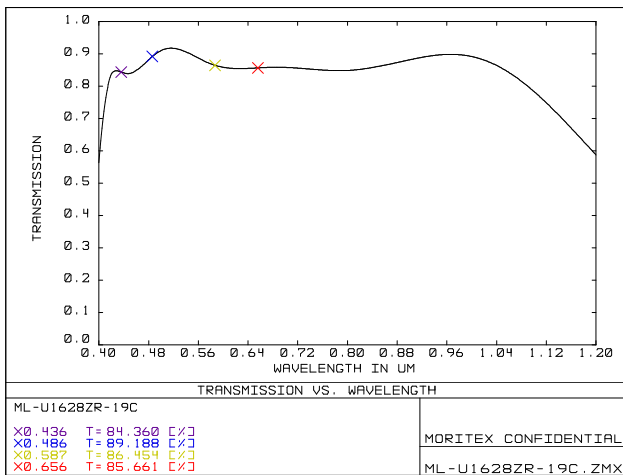
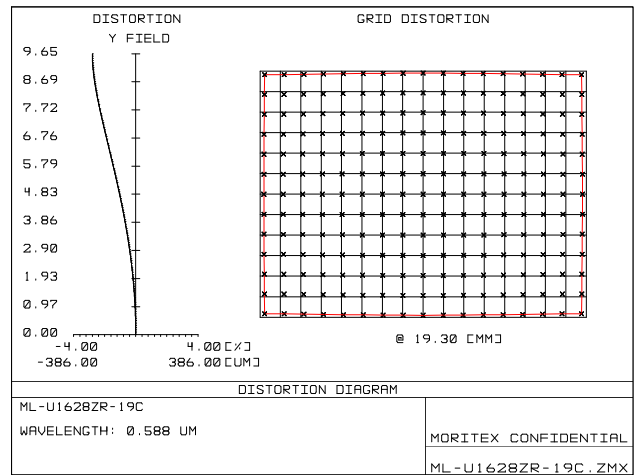
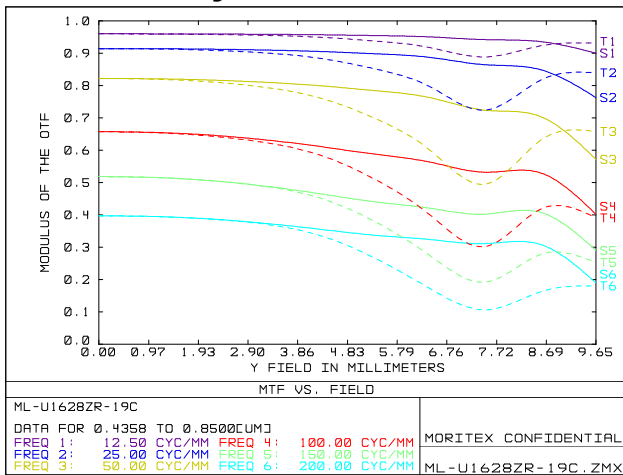

内容は、通知なしに随時変更されることがあります。

The content is subject to change at any time without notification.

株式会社 **モリテックス** MORITEX Corporation

Technology center Lens design & Development technology

moritex.mvs@moritex.com

www.moritex.com

