

# ML-U1228ZR-19C

## ML-U-ZR-19 series



Drawing No. A25280

レンズ形式	Lens Type	CCTV Lens	
フォーカス位置	Focus Position	Reference Magnification	M.O.D
光学倍率	Magnification	0.024	0.100
焦点距離 (mm)	Focal Length	12.13	11.50
Fno	Fno	2.80~16.00	
使用波長域 (nm)	Wavelength range used	450~850	
NA	Numerical Aperture	-	-
WD/OD (mm)	Working/Object Distance	500.0 / 501.8	100.0 / 101.8
O/I (mm)	Object to Image Distance	595.25	195.25
鏡筒長 (mm)	Mechanical Tube Length	77.90	
レンズバック (mm)	Lens Back	7.41	7.41
被写界深度 (mm)	DOF @PCoC $\phi$ 0.04mm	407.674	22.540
分解能 ( $\mu$ m)	Resolution @ $\lambda$ =550nm	-	-
前側/後側主点位置 (mm)	Front/Rear Principal Position	24.99 / -4.98	24.59 / -5.18
入射/出射瞳位置 (mm)	Entrance/Exit Pupil Position	16.40 / -34.40	16.34 / -34.40
入射/出射瞳径 (mm)	Entrance/Exit Pupil Diameter	4.34 / 14.86	4.20 / 14.86
画角 (deg.) H×V	Angle Of View	65.98 x 51.57	68.16 x 53.31
TVディストーション (%)	TV Distortion	-0.960	-1.417
周辺光量比 (%)	Relative Illumination	51.90	54.05
質量 (g)	Weight	259.0	
マウント	Mount	C Mount	
イメージサークル径 (mm)	Image Circle	$\phi$ 19.3	
最大適合カメラ	Largest Compatible Camera	1.2 Inch	

### ML-U1228ZR-19C

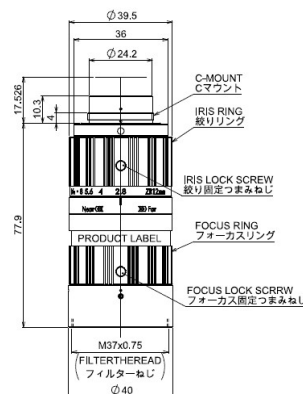

### WD=500.0mm Fno2.8

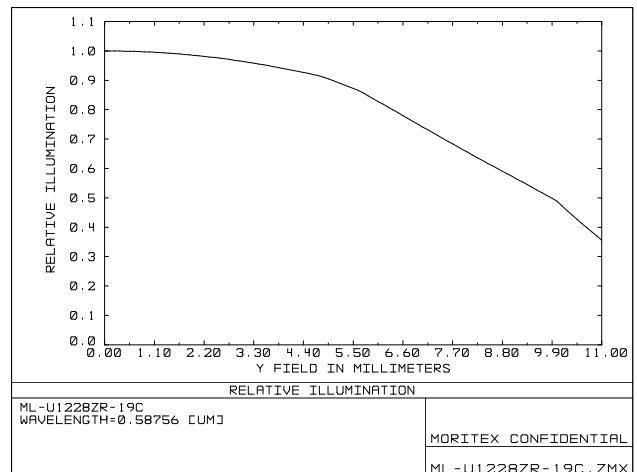
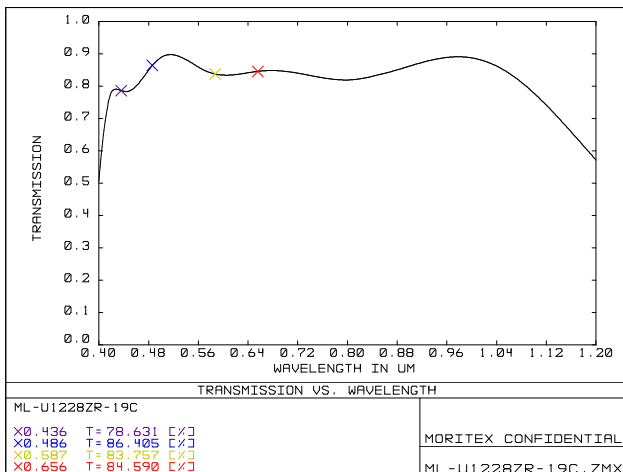
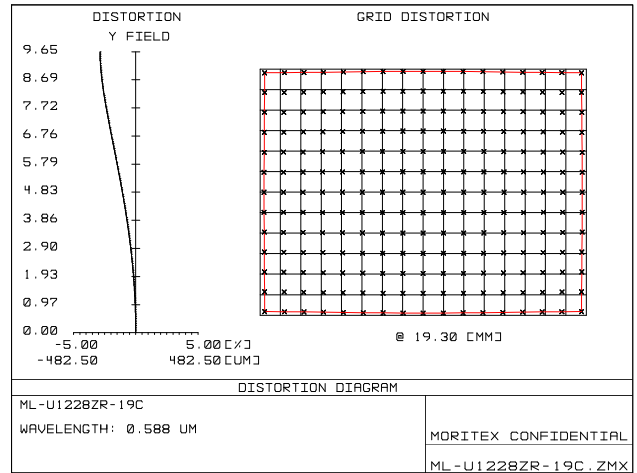
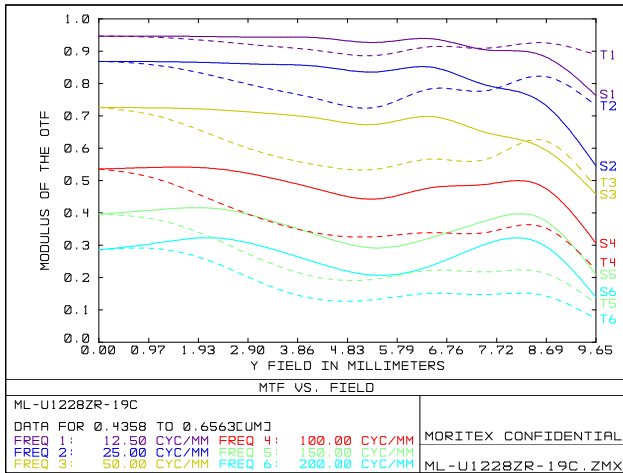

内容は、通知なしに随時変更されることがあります。

The content is subject to change at any time without notification.

株式会社 **モリテックス** MORITEX Corporation

Technology center Lens design & Development technology

moritex.mvs@moritex.com

www.moritex.com



### WD=100.0mm Fno2.8

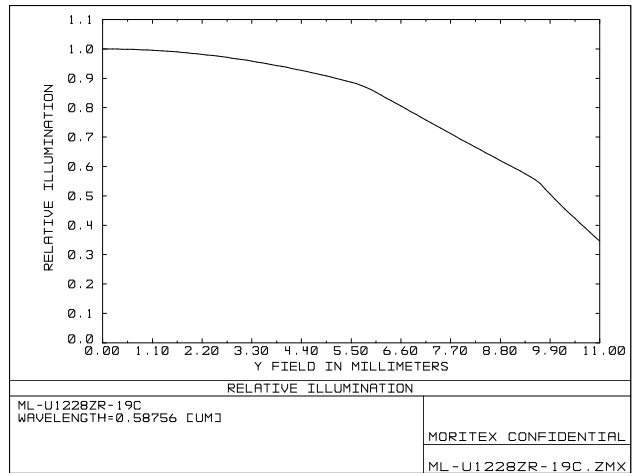
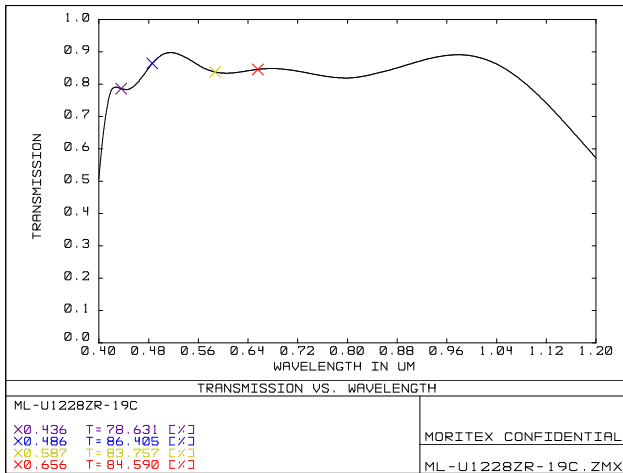
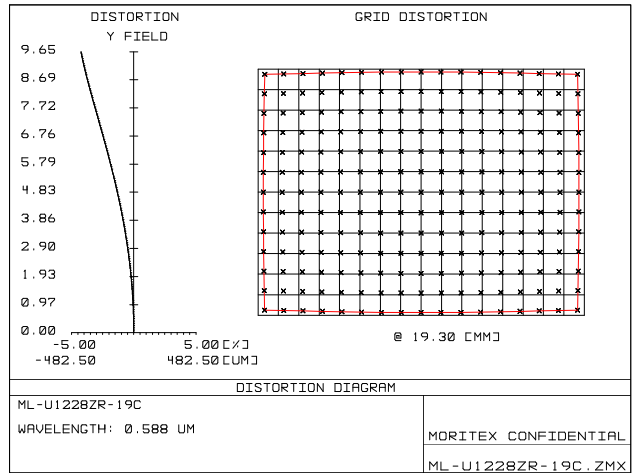
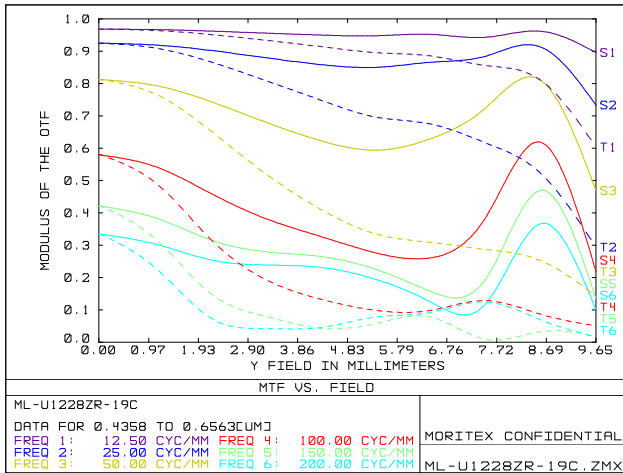

内容は、通知なしに随時変更されることがあります。

The content is subject to change at any time without notification.

株式会社 **モリテックス** MORITEX Corporation

Technology center Lens design & Development technology

moritex.mvs@moritex.com

www.moritex.com



## WD=Infinity Fno2.8

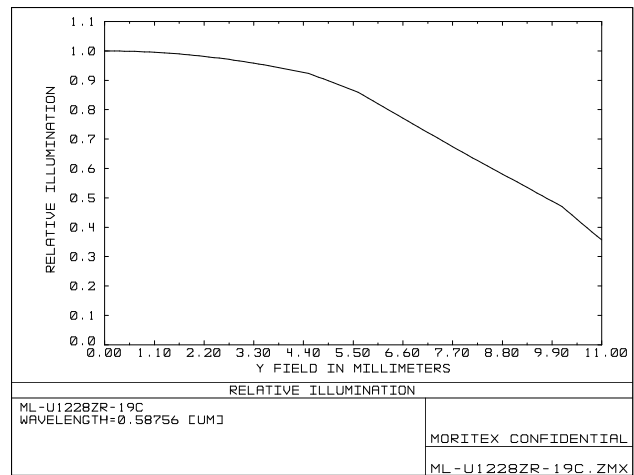
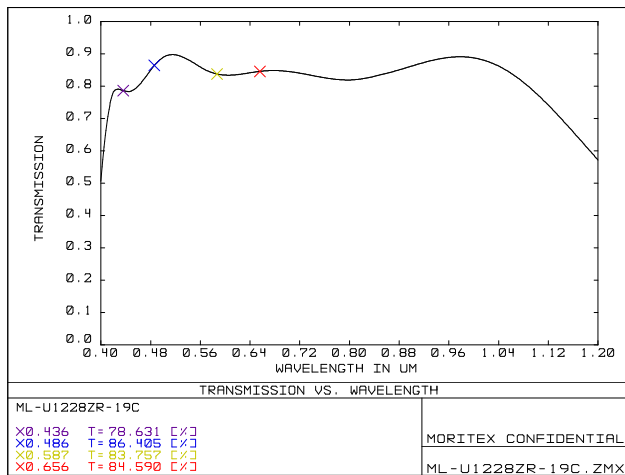
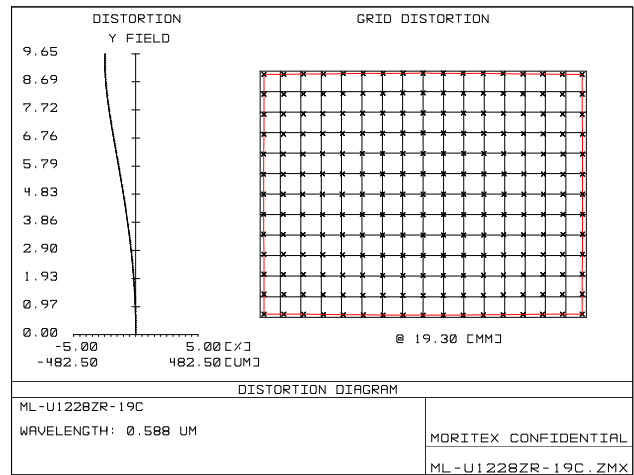
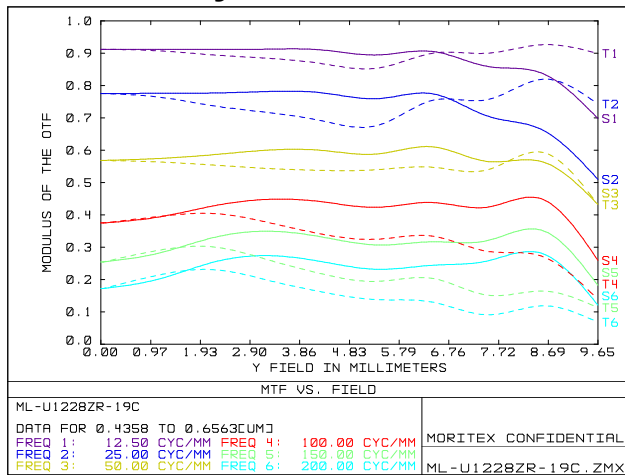

内容は、通知なしに随時変更されることがあります。

The content is subject to change at any time without notification.

株式会社 **モリテックス** MORITEX Corporation

Technology center Lens design & Development technology

moritex.mvs@moritex.com

www.moritex.com



### WD=500.0mm Fno3.8

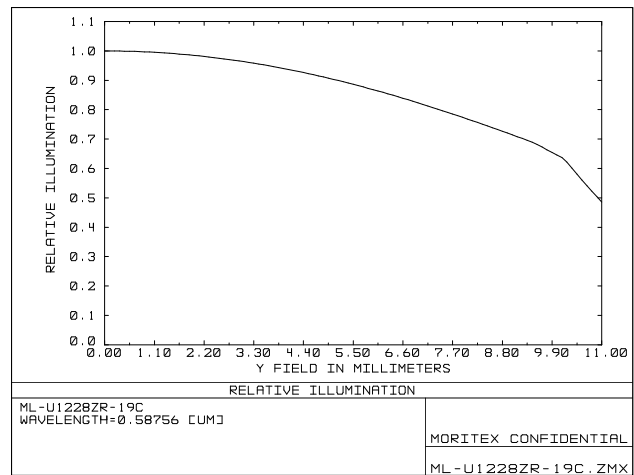
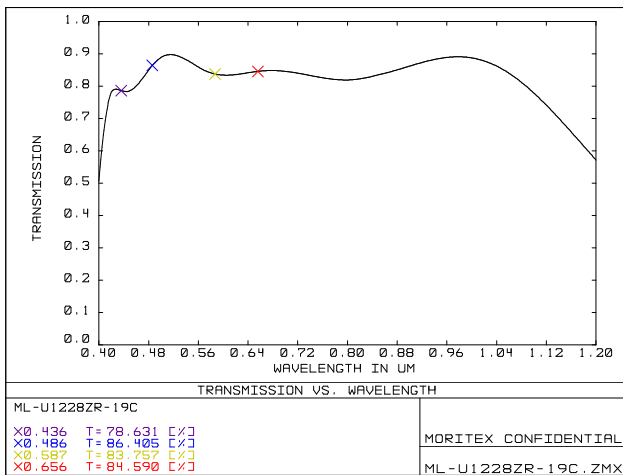
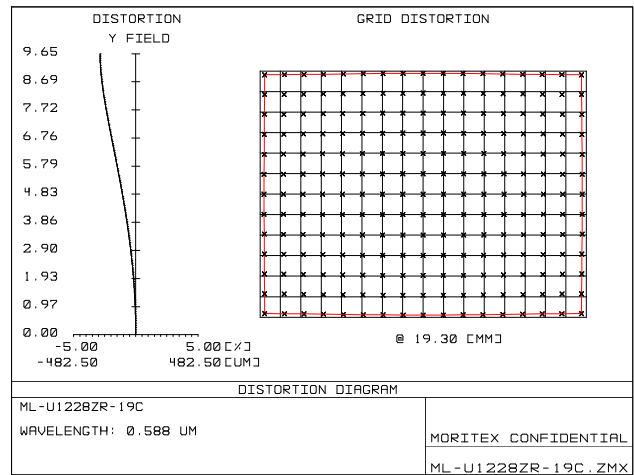
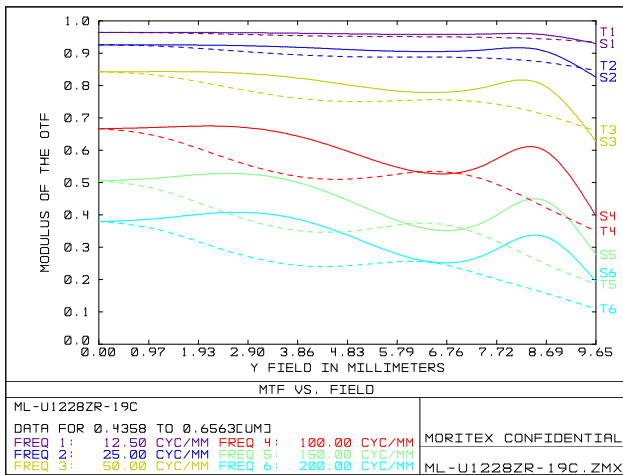

内容は、通知なしに随時変更されることがあります。

The content is subject to change at any time without notification.

株式会社 **モリテックス** MORITEX Corporation

Technology center Lens design & Development technology

moritex.mvs@moritex.com

www.moritex.com



### WD=100.0mm Fno3.8

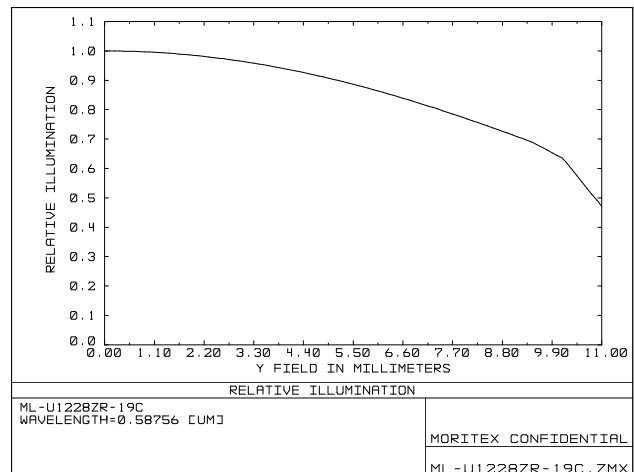
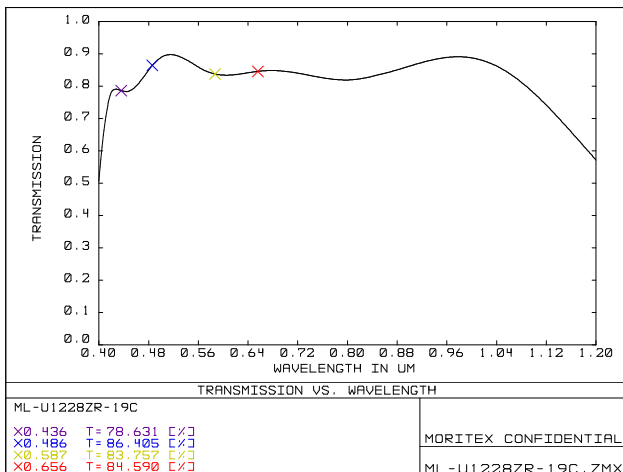
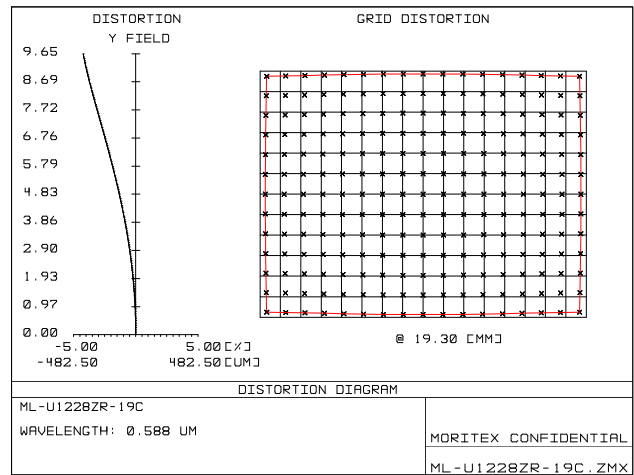
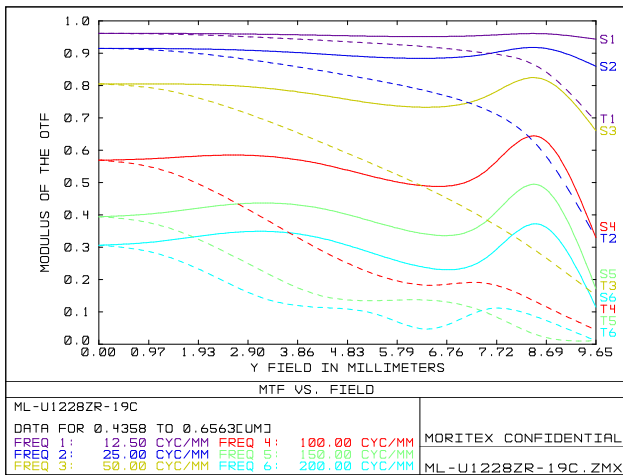

内容は、通知なしに随時変更されることがあります。

The content is subject to change at any time without notification.

株式会社 **モリテックス** MORITEX Corporation

Technology center Lens design & Development technology

moritex.mvs@moritex.com

www.moritex.com



## WD=Infinity Fno3.8

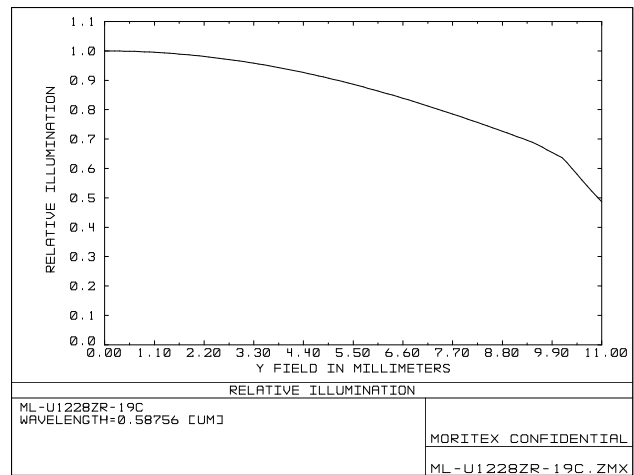
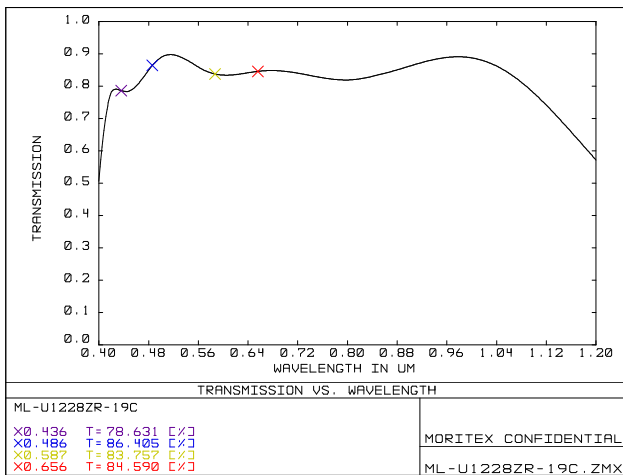
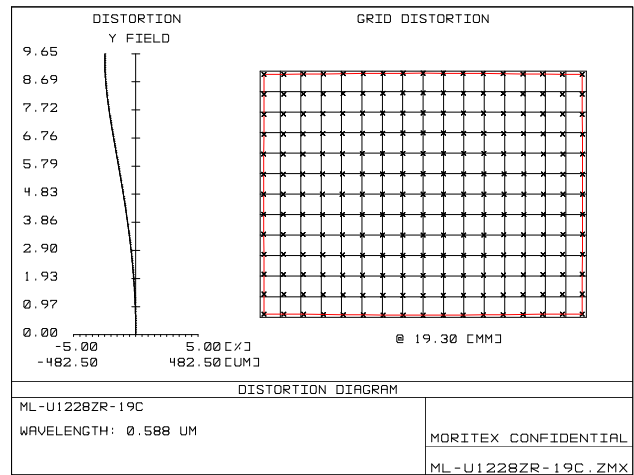
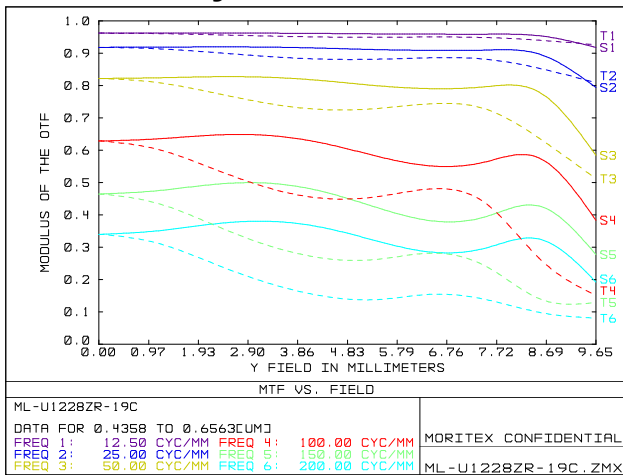

内容は、通知なしに随時変更されることがあります。

The content is subject to change at any time without notification.

株式会社 **モリテックス** MORITEX Corporation

Technology center Lens design & Development technology

moritex.mvs@moritex.com

www.moritex.com

