

ML-MC75AR

ML-MC-AR series



Drawing No. A24863

レンズ形式	Lens Type	Macro Lens
光学倍率	Magnification	0.17~0.38
焦点距離 (mm)	Focal Length	73.96
Fno	Fno	3.50~16.00
使用波長域 (nm)	Wavelength range used	400~700
NA	Numerical Aperture	-
WD/OD (mm)	Working/Object Distance	500.0~270.0 / 505.1~275.1
O/I (mm)	Object to Image Distance	591.77~377.11
鏡筒長 (mm)	Mechanical Tube Length	74.20~89.60
レンズバック (mm)	Lens Back	30.17~45.51
被写界深度 (mm)	DOF @PCoC ϕ 0.04mm	12.111~3.218
分解能 (μ m)	Resolution @ λ =550nm	-
前側/後側主点位置 (mm)	Front/Rear Principal Position	-7.98 / -56.65
入射/出射瞳位置 (mm)	Entrance/Exit Pupil Position	47.59 / -24.92
入射/出射瞳径 (mm)	Entrance/Exit Pupil Diameter	21.14 / 12.07
画角 (deg.) H×V	Angle Of View @WD=500	2.89x2.14(1/3 Inch) 3.88x2.89(1/2 Inch) 4.57x3.41(1/1.7 Inch)
TVディストーション (%)	TV Distortion @WD=500	\leq 0.018(1/3 Inch) \leq 0.029(1/2 Inch) \leq 0.038(1/1.7 Inch)
周辺光量比 (%)	Relative Illumination @WD=500	\geq 96.19(1/3 Inch) \geq 93.52(1/2 Inch) \geq 91.58(1/1.7 Inch)
質量 (g)	Weight	138.0
マウント	Mount	C Mount
イメージサークル径 (mm)	Image Circle	ϕ 9.4
最大適合カメラ	Largest Compatible Camera	1/1.7 Inch

ML-MC75AR

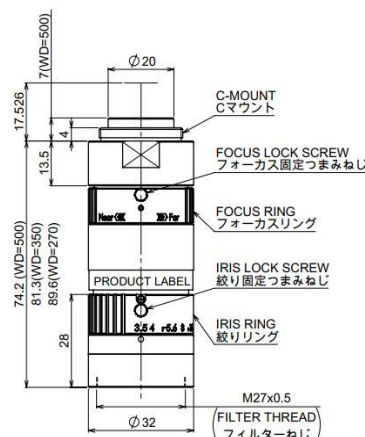

0.17x Fno3.5

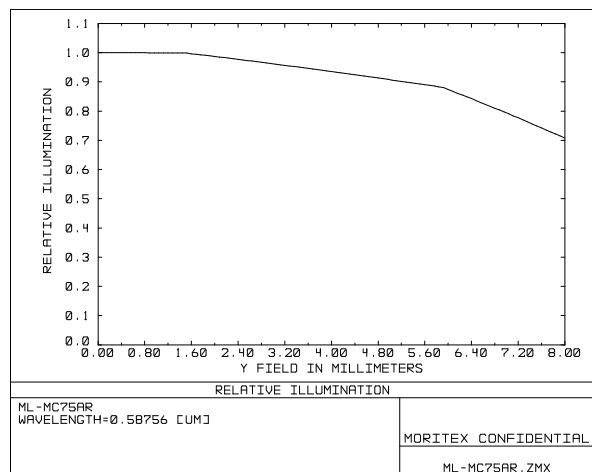
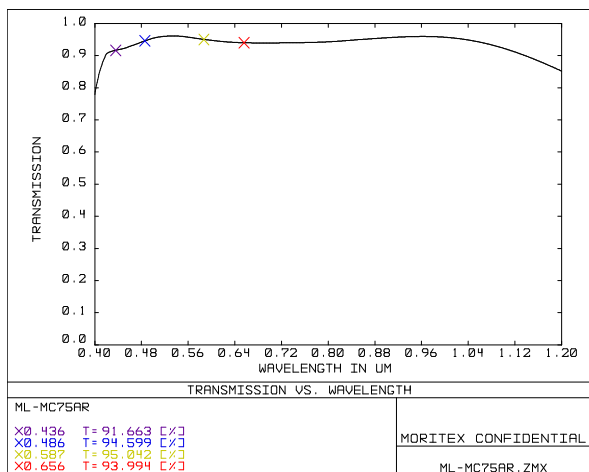
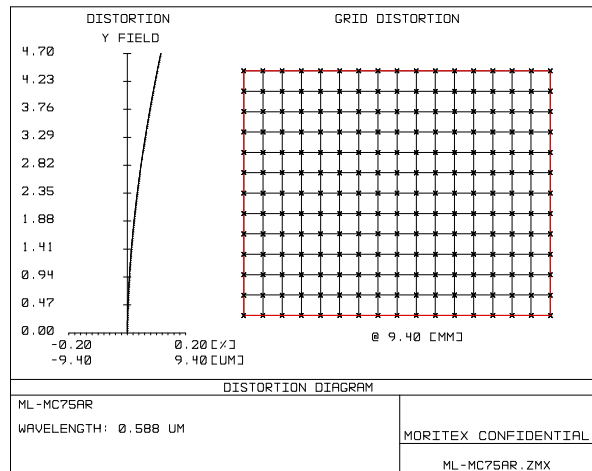
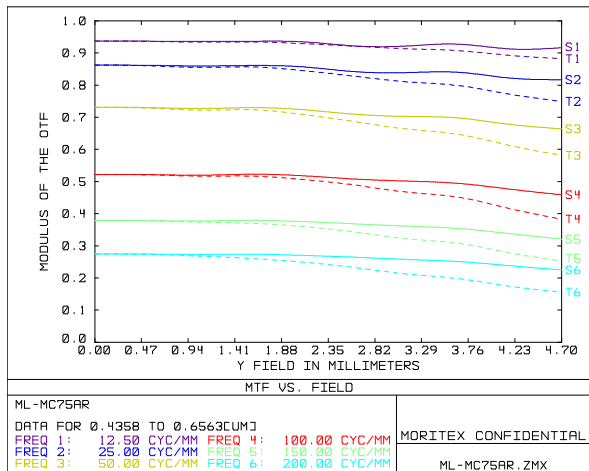

内容は、通知なしに随時変更されることがあります。

The content is subject to change at any time without notification.

株式会社 **モリテックス** MORITEX Corporation

Technology center Lens design & Development technology

moritex.mvs@moritex.com

www.moritex.com



0.38x Fno3.5

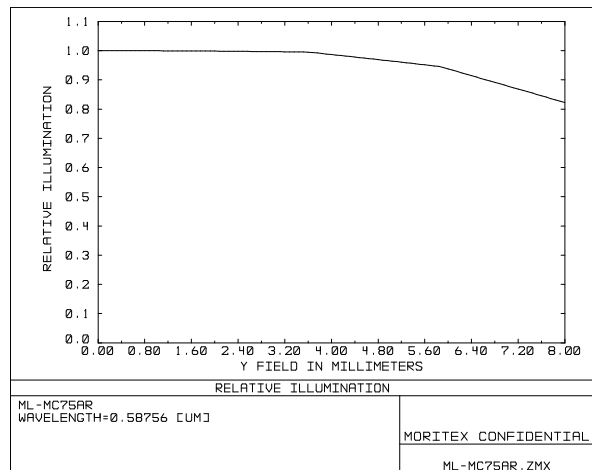
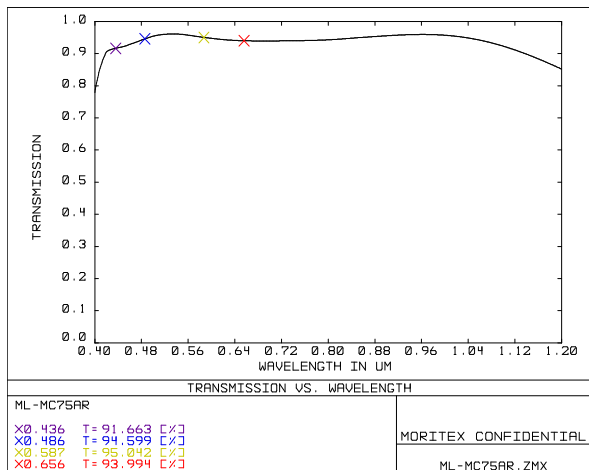
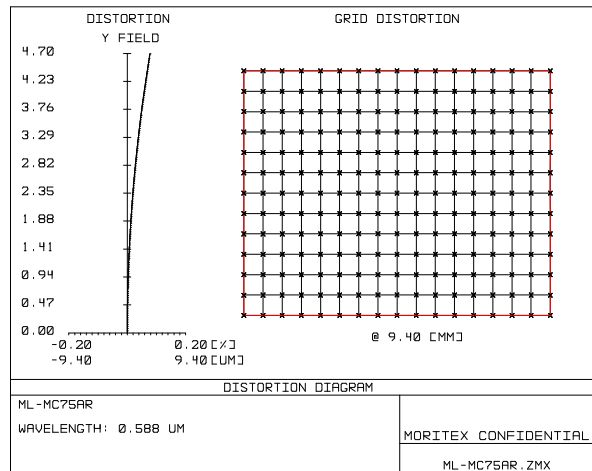
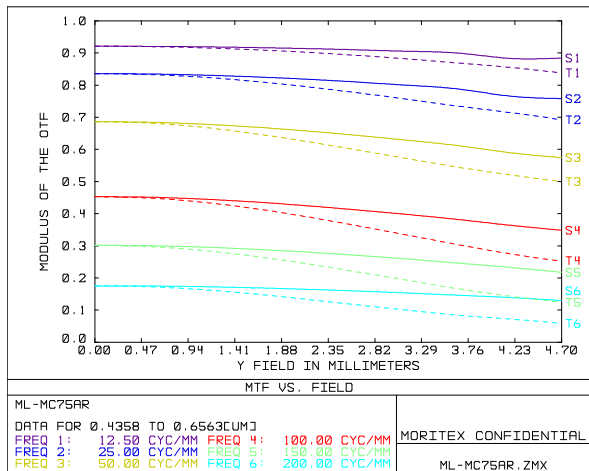

内容は、通知なしに随時変更されることがあります。

The content is subject to change at any time without notification.

株式会社 **モリテックス** MORITEX Corporation

Technology center Lens design & Development technology

moritex.mvs@moritex.com

www.moritex.com



0.27x Fno3.5

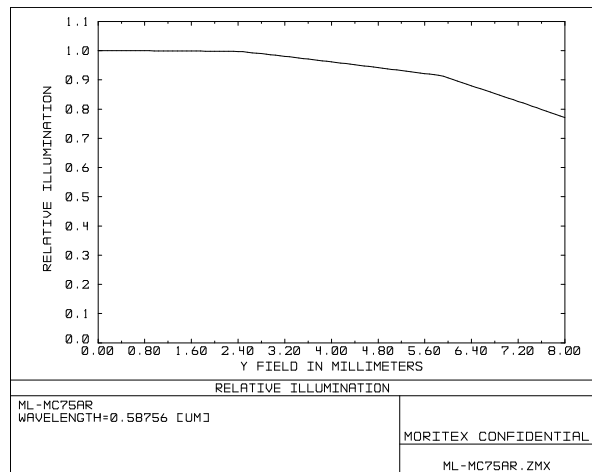
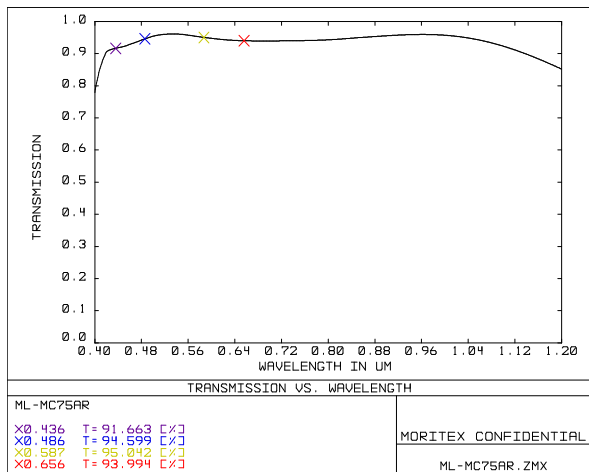
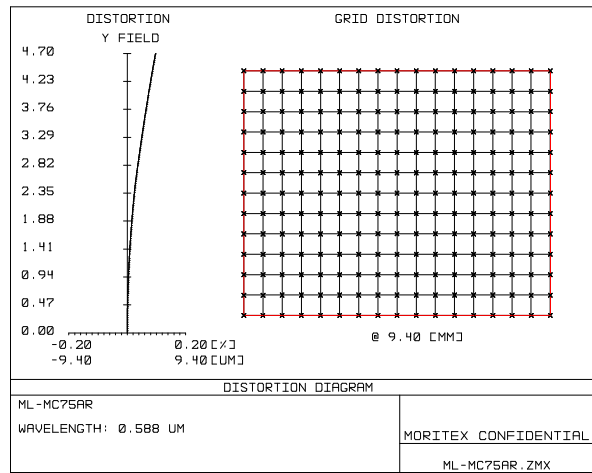
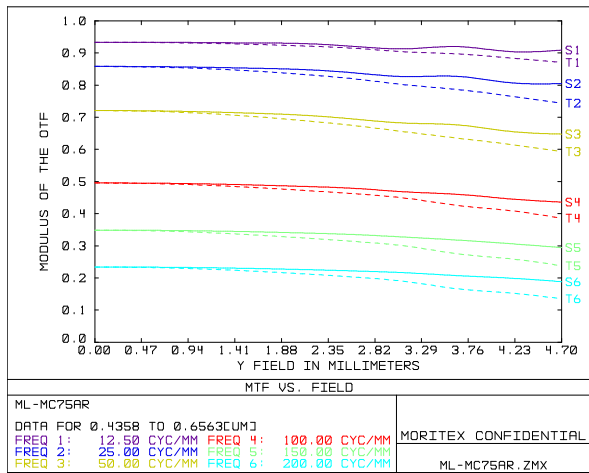

内容は、通知なしに随時変更されることがあります。

The content is subject to change at any time without notification.

株式会社 **モリテックス** MORITEX Corporation

Technology center Lens design & Development technology

moritex.mvs@moritex.com

www.moritex.com



0.17x Fno4.0

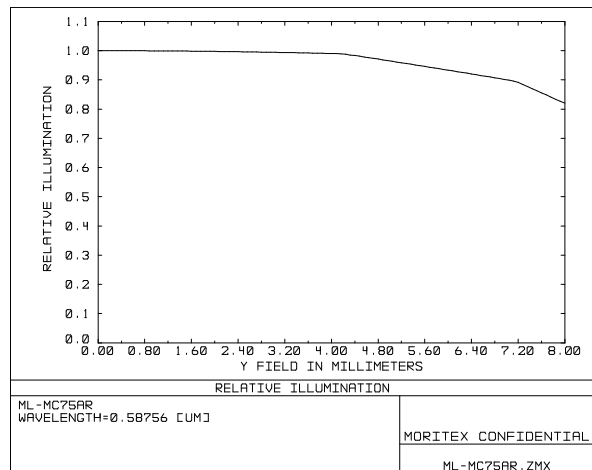
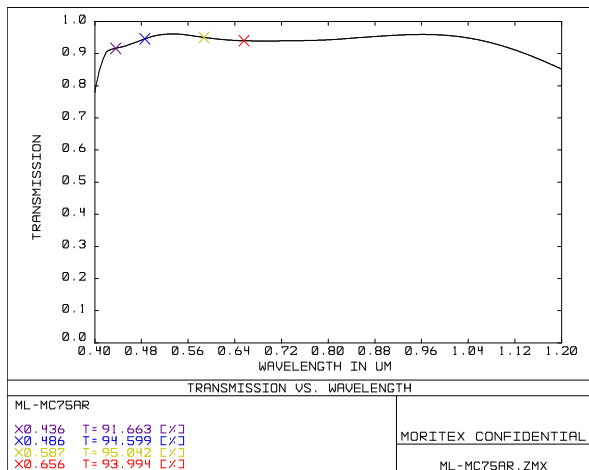
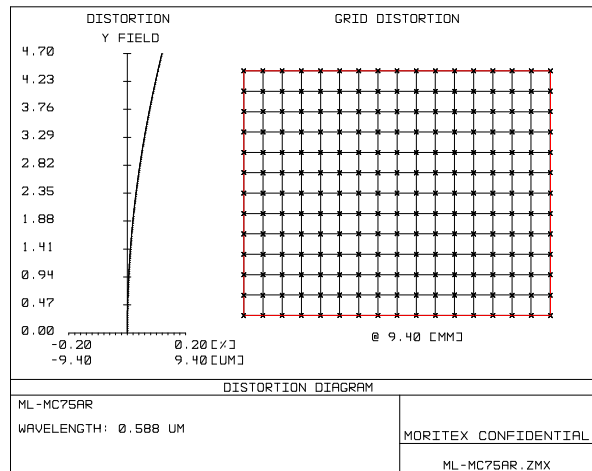
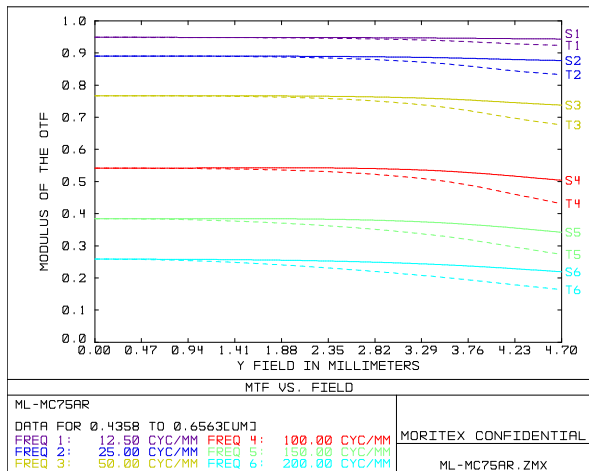

内容は、通知なしに随時変更されることがあります。

The content is subject to change at any time without notification.

株式会社 **モリテックス** MORITEX Corporation

Technology center Lens design & Development technology

moritex.mvs@moritex.com

www.moritex.com



0.38x Fno4.0

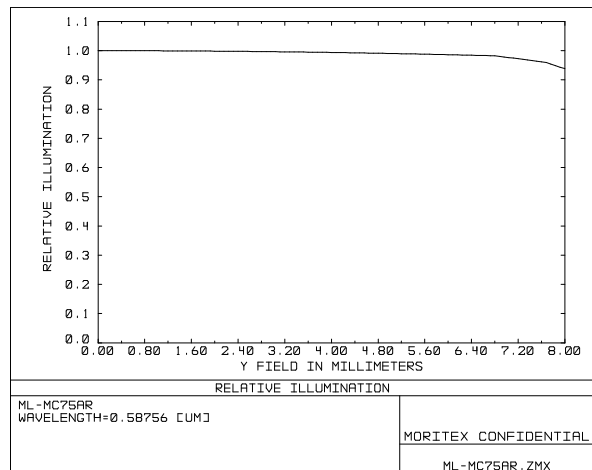
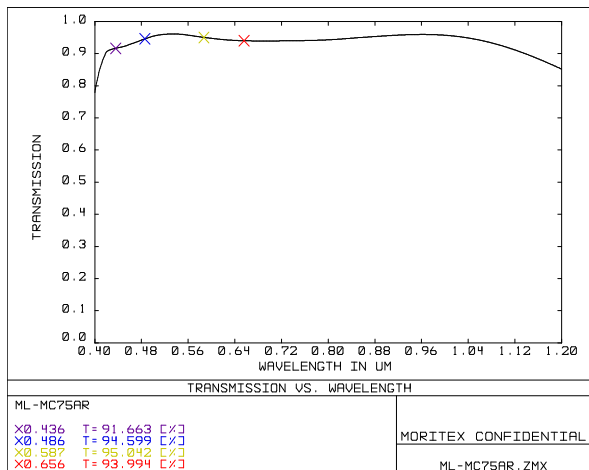
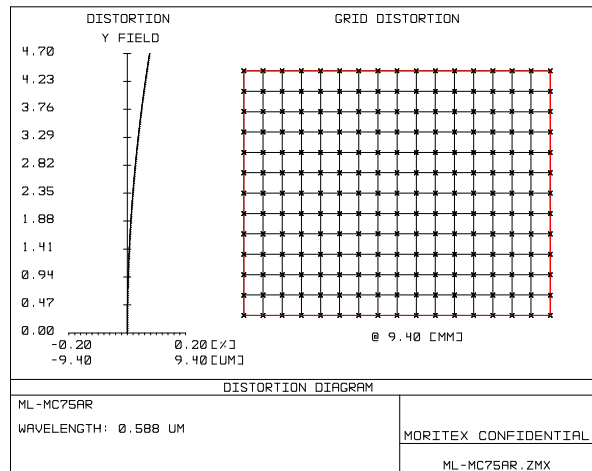
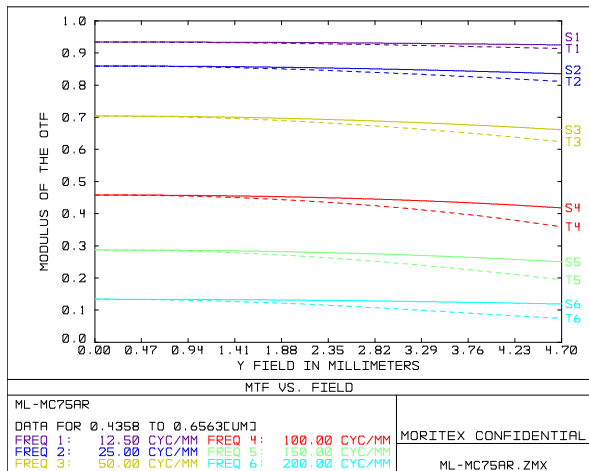

内容は、通知なしに随時変更されることがあります。

The content is subject to change at any time without notification.

株式会社 **モリテックス** MORITEX Corporation

Technology center Lens design & Development technology

moritex.mvs@moritex.com

www.moritex.com



0.27x Fno4.0

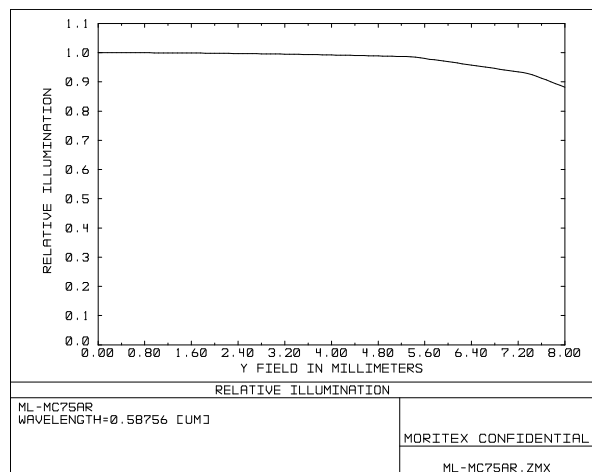
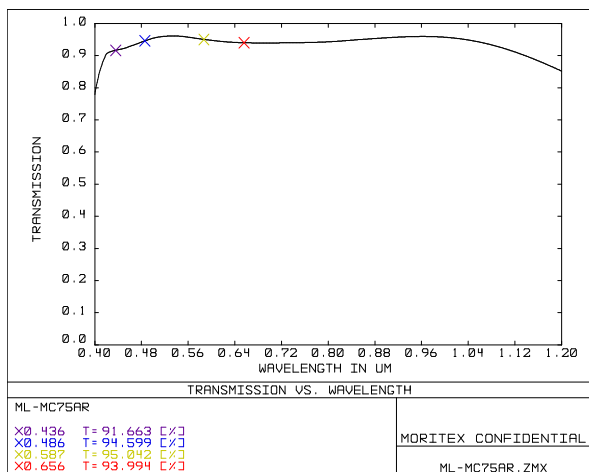
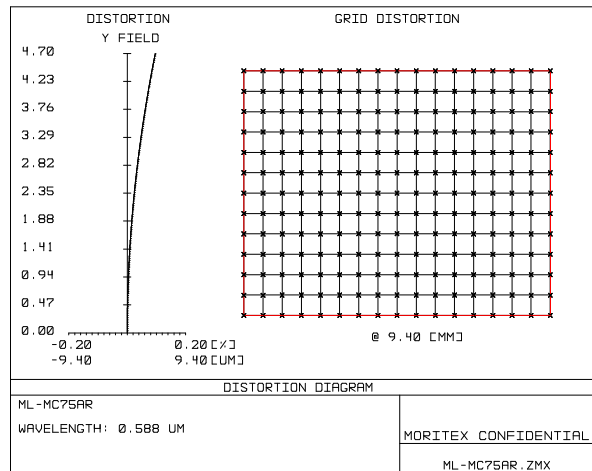
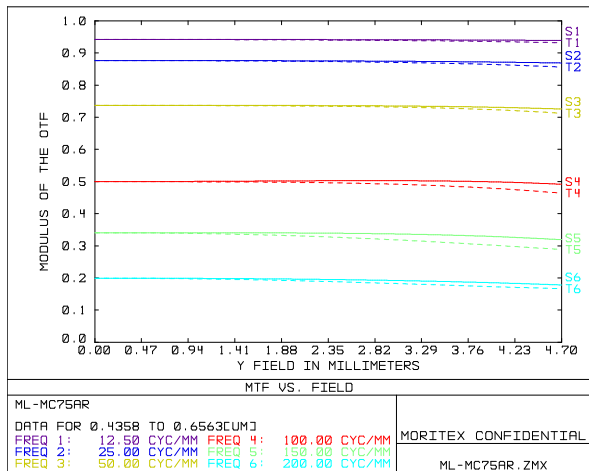

内容は、通知なしに随時変更されることがあります。

The content is subject to change at any time without notification.

株式会社 **モリテックス** MORITEX Corporation

Technology center Lens design & Development technology

moritex.mvs@moritex.com

www.moritex.com

