

ML-MC75AR-LWD

ML-MC-AR series



Drawing No. A24870

レンズ形式	Lens Type	Macro Lens
光学倍率	Magnification	0.08~0.18
焦点距離 (mm)	Focal Length	73.98
Fno	Fno	3.60~16.00
使用波長域 (nm)	Wavelength range used	400~700
NA	Numerical Aperture	-
WD/OD (mm)	Working/Object Distance	1000.0~500.0 / 1005.1~505.1
O/I (mm)	Object to Image Distance	1085.18~592.24
鏡筒長 (mm)	Mechanical Tube Length	67.70~74.70
レンズバック (mm)	Lens Back	22.28~29.34
被写界深度 (mm)	DOF @PCoC ϕ 0.04mm	50.993~12.002
分解能 (μ m)	Resolution @ λ =550nm	-
前側/後側主点位置 (mm)	Front/Rear Principal Position	-11.49 / -57.58
入射/出射瞳位置 (mm)	Entrance/Exit Pupil Position	29.83 / -31.07
入射/出射瞳径 (mm)	Entrance/Exit Pupil Diameter	20.55 / 13.18
画角 (deg.) H×V	Angle Of View @WD=1000	3.32x2.48(1/3 Inch) 4.43x3.32(1/2 Inch) 5.21x3.90(1/1.7 Inch)
TVディストーション (%)	TV Distortion @WD=1000	\leq 0.019(1/3 Inch) \leq 0.032(1/2 Inch) \leq 0.042(1/1.7 Inch)
周辺光量比 (%)	Relative Illumination @WD=1000	\geq 97.09(1/3 Inch) \geq 95.12(1/2 Inch) \geq 93.67(1/1.7 Inch)
質量 (g)	Weight	122.0
マウント	Mount	C Mount
イメージサークル径 (mm)	Image Circle	ϕ 9.4
最大適合カメラ	Largest Compatible Camera	1/1.7 Inch

ML-MC75AR-LWD

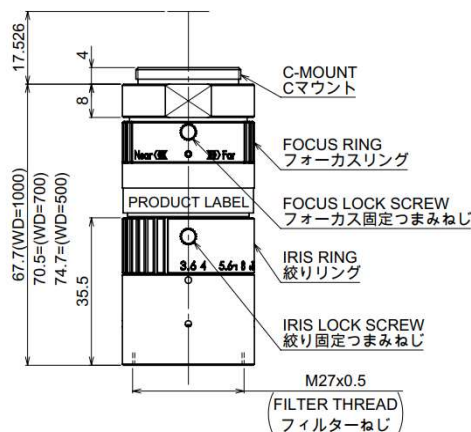

0.08x Fno3.6

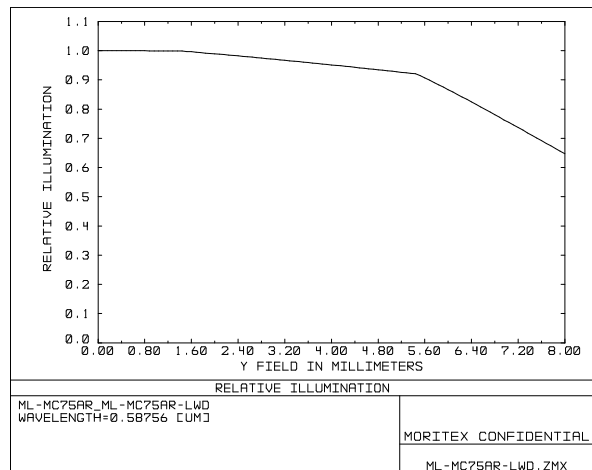
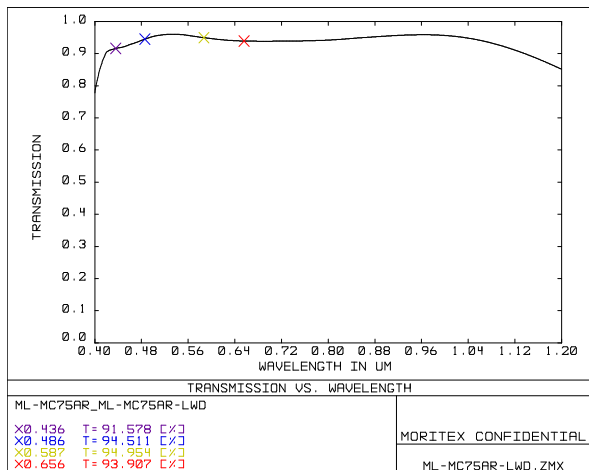
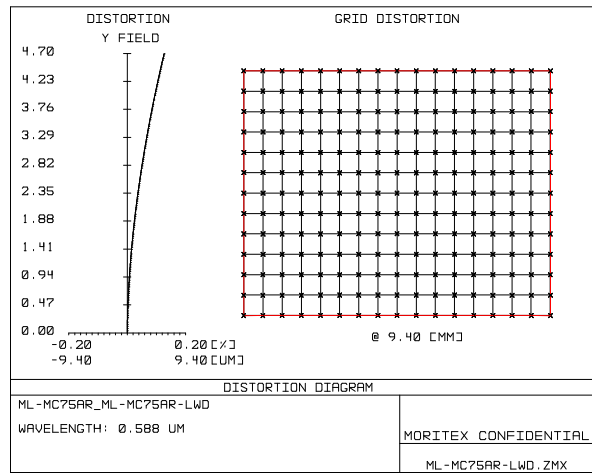
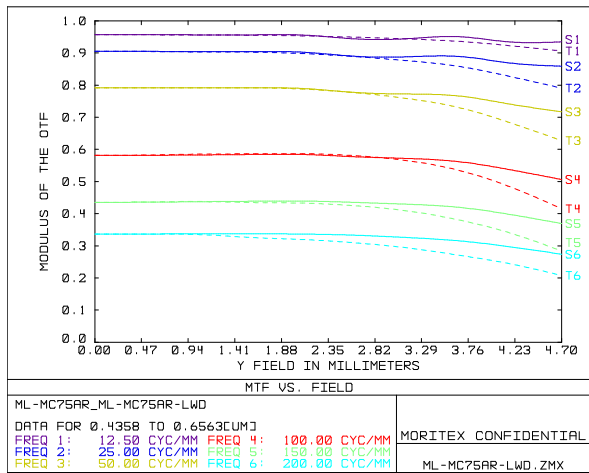

内容は、通知なしに随時変更されることがあります。

The content is subject to change at any time without notification.

株式会社 **モリテックス** MORITEX Corporation

Technology center Lens design & Development technology

moritex.mvs@moritex.com

www.moritex.com



0.18x Fno3.6

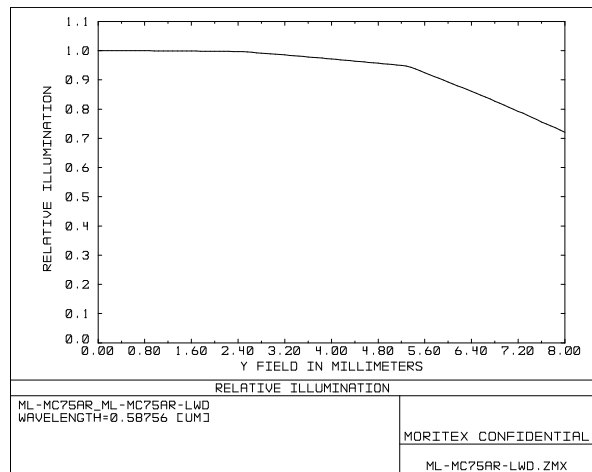
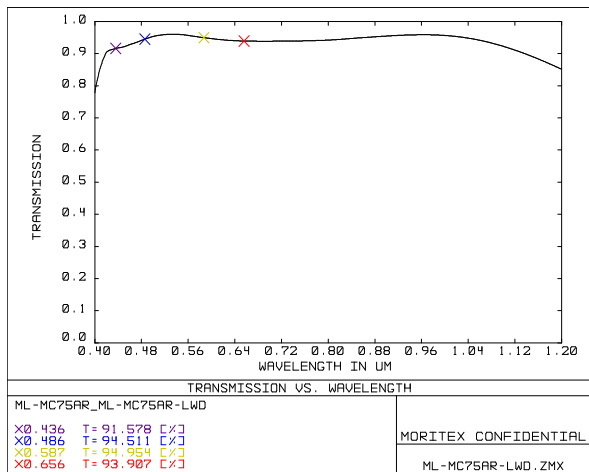
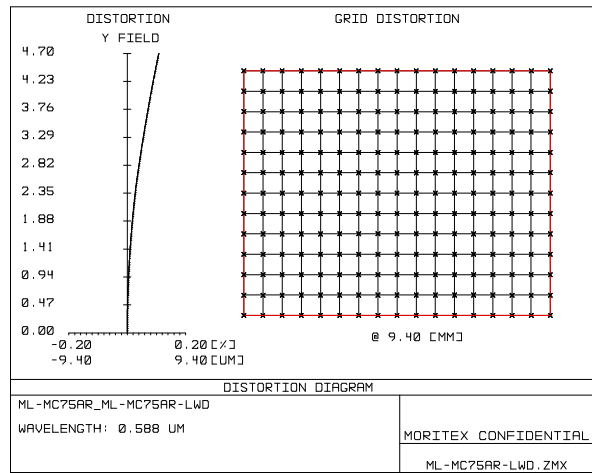
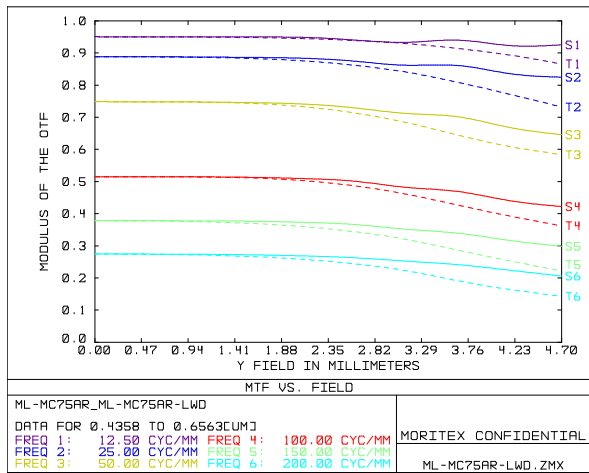

内容は、通知なしに随時変更されることがあります。

The content is subject to change at any time without notification.

株式会社 **モリテックス** MORITEX Corporation

Technology center Lens design & Development technology

moritex.mvs@moritex.com

www.moritex.com



0.12x Fno3.6

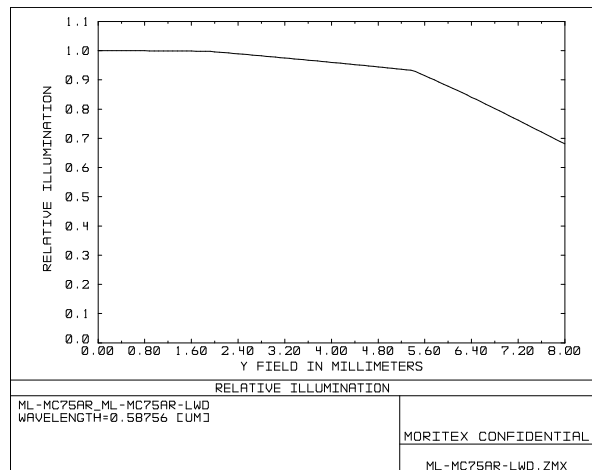
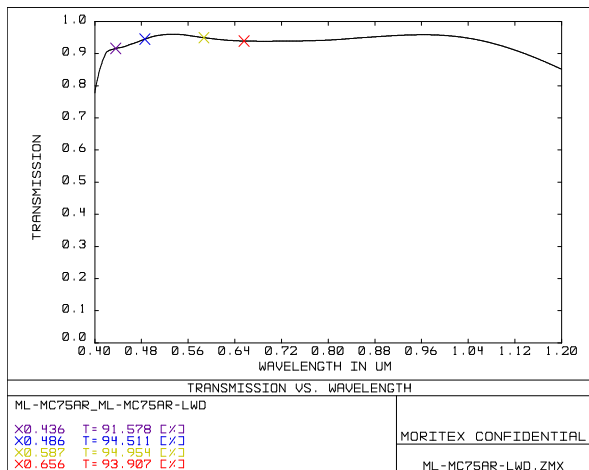
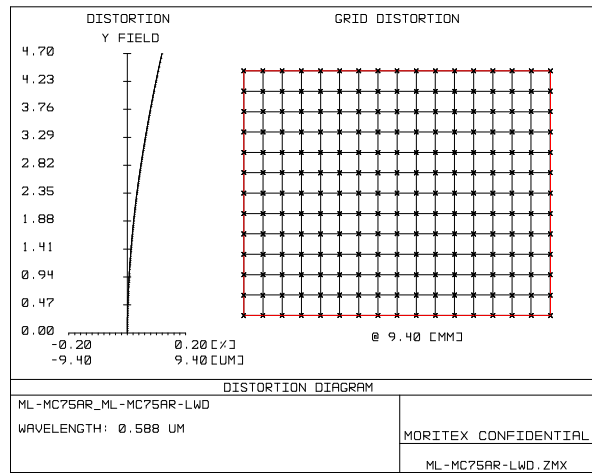
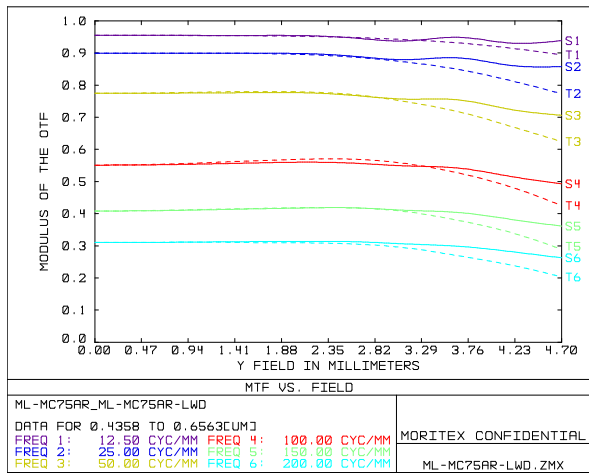

内容は、通知なしに随時変更されることがあります。

The content is subject to change at any time without notification.

株式会社 **モリテックス** MORITEX Corporation

Technology center Lens design & Development technology

moritex.mvs@moritex.com

www.moritex.com



0.08x Fno4.0

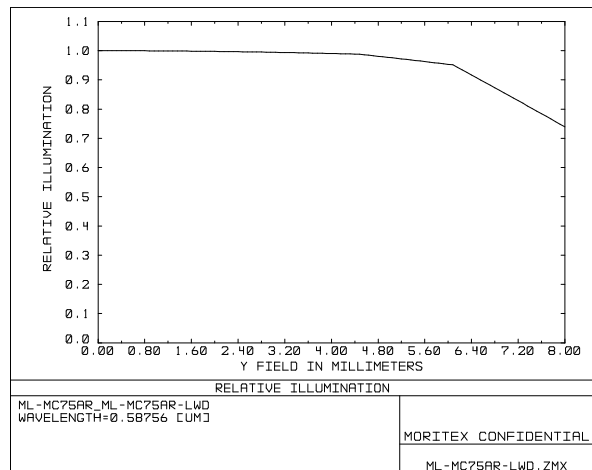
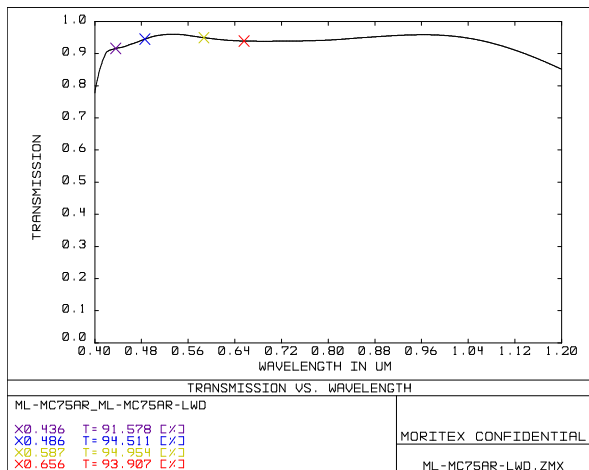
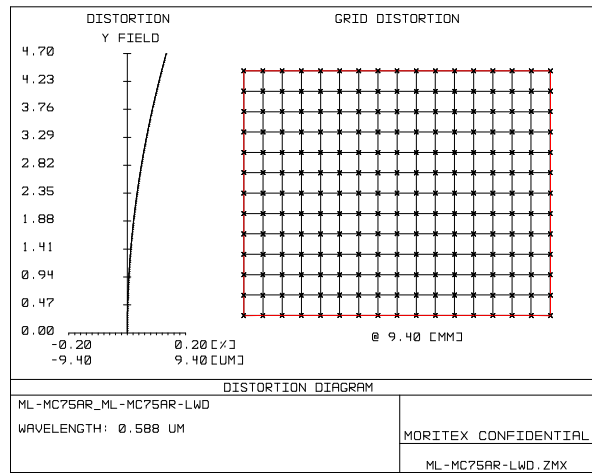
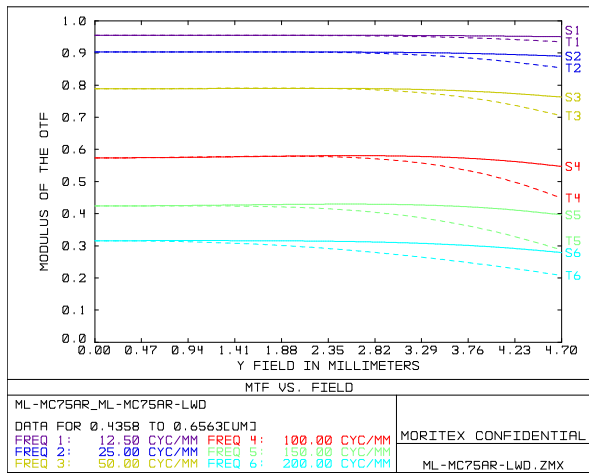

内容は、通知なしに随時変更されることがあります。

The content is subject to change at any time without notification.

株式会社 **モリテックス** MORITEX Corporation

Technology center Lens design & Development technology

moritex.mvs@moritex.com

www.moritex.com



0.18x Fno4.0

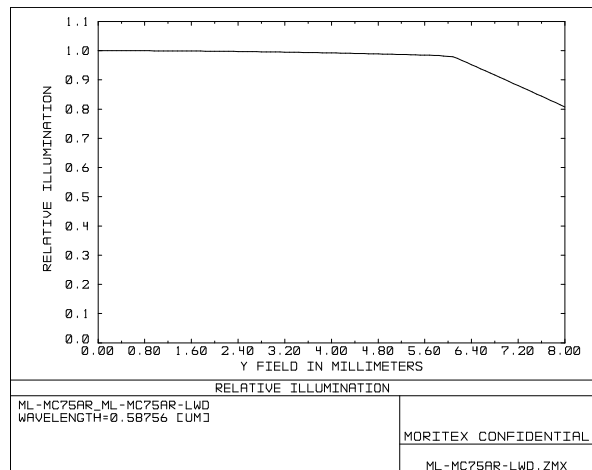
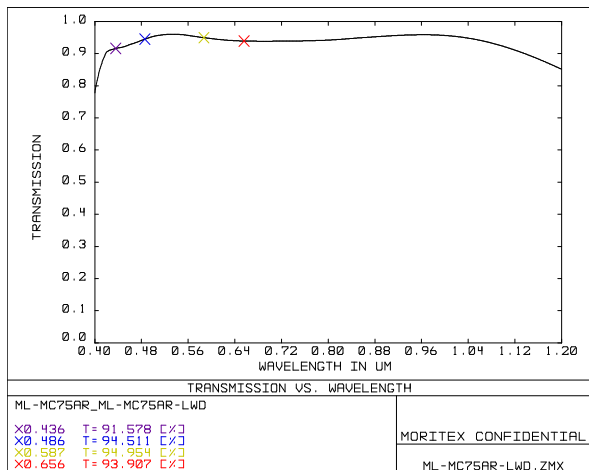
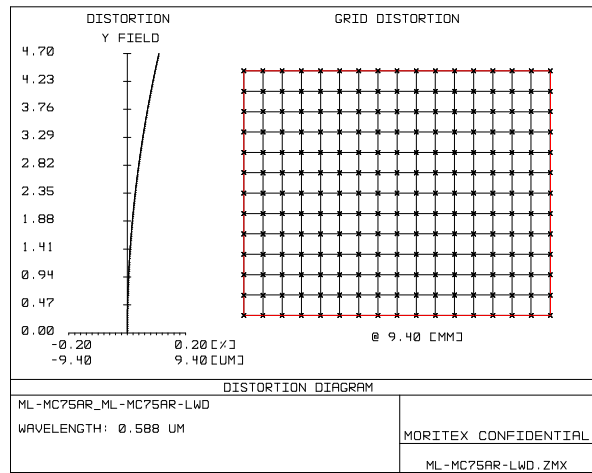
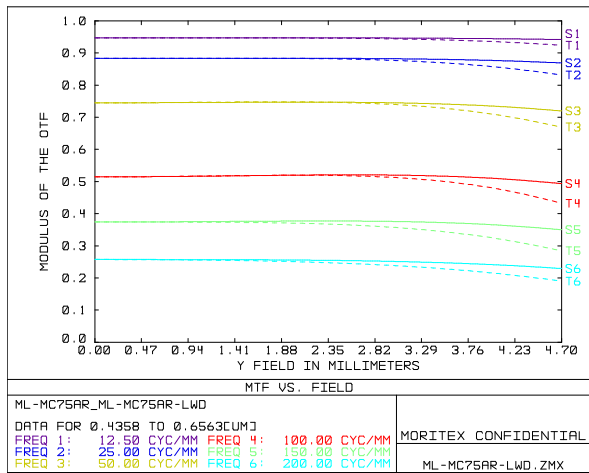

内容は、通知なしに随時変更されることがあります。

The content is subject to change at any time without notification.

株式会社 **モリテックス** MORITEX Corporation

Technology center Lens design & Development technology

moritex.mvs@moritex.com

www.moritex.com



0.12x Fno4.0

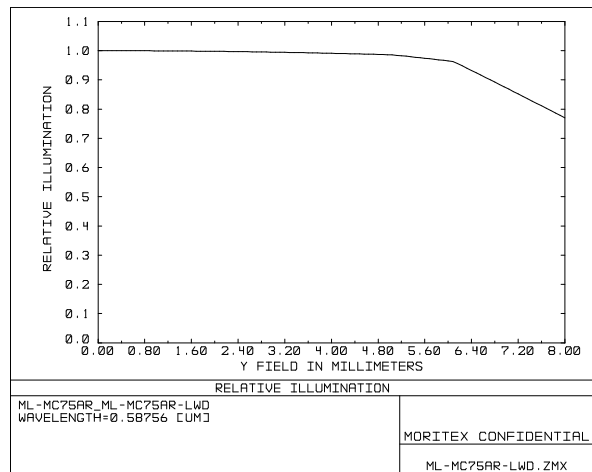
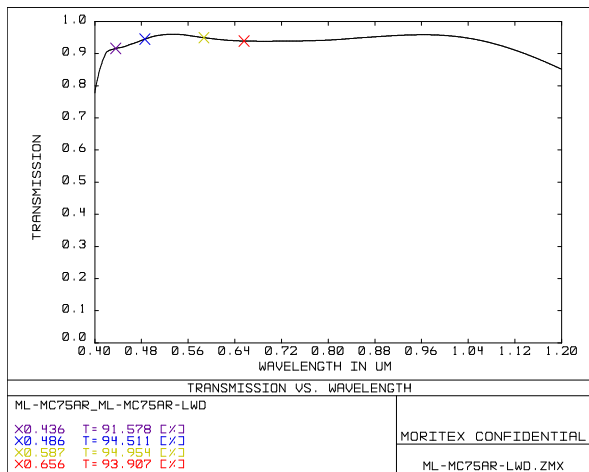
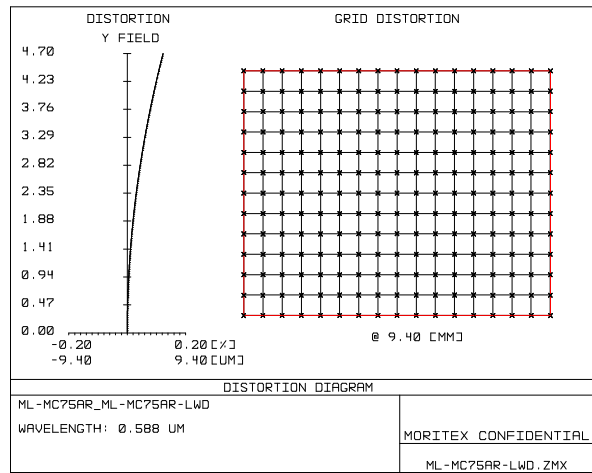
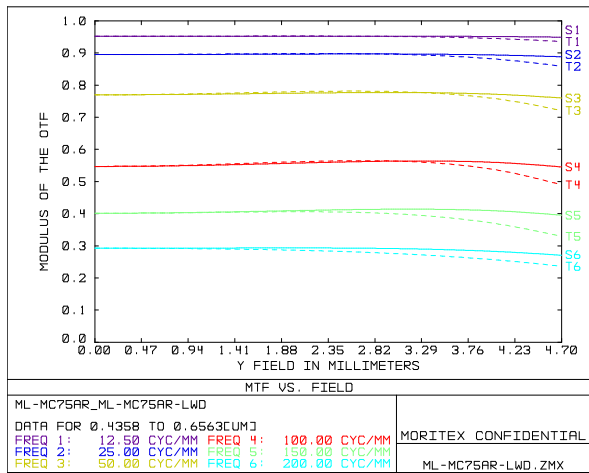

内容は、通知なしに随時変更されることがあります。

The content is subject to change at any time without notification.

株式会社 **モリテックス** MORITEX Corporation

Technology center Lens design & Development technology

moritex.mvs@moritex.com

www.moritex.com

