

ML-MC50AR

ML-MC-AR series



Drawing No. A24875

レンズ形式	Lens Type	Macro Lens
光学倍率	Magnification	0.50~0.80
焦点距離 (mm)	Focal Length	50.30
Fno	Fno	2.80~16.00
使用波長域 (nm)	Wavelength range used	400~700
NA	Numerical Aperture	-
WD/OD (mm)	Working/Object Distance	148.8~111.0 / 155.5~117.7
O/I (mm)	Object to Image Distance	231.45~208.78
鏡筒長 (mm)	Mechanical Tube Length	65.20~80.30
レンズバック (mm)	Lens Back	29.95~45.01
被写界深度 (mm)	DOF @PCoC ϕ 0.04mm	1.543~0.741
分解能 (μ m)	Resolution @ λ =550nm	-
前側/後側主点位置 (mm)	Front/Rear Principal Position	-4.66 / -45.37
入射/出射瞳位置 (mm)	Entrance/Exit Pupil Position	9.39 / -34.39
入射/出射瞳径 (mm)	Entrance/Exit Pupil Diameter	17.58 / 13.74
画角 (deg.) H×V	Angle Of View @WD=148.8	3.35x2.52(1/3 Inch) 4.47x3.35(1/2 Inch) 5.20x3.90(1/1.7 Inch)
TVディストーション (%)	TV Distortion @WD=148.8	\leq 0.010(1/3 Inch) \leq 0.017(1/2 Inch) \leq 0.023(1/1.7 Inch)
周辺光量比 (%)	Relative Illumination @WD=148.8	\geq 98.06(1/3 Inch) \geq 98.79(1/2 Inch) \geq 97.33(1/1.7 Inch)
質量 (g)	Weight	113.5
マウント	Mount	C Mount
イメージサークル径 (mm)	Image Circle	ϕ 9.3
最大適合カメラ	Largest Compatible Camera	1/1.7 Inch

ML-MC50AR

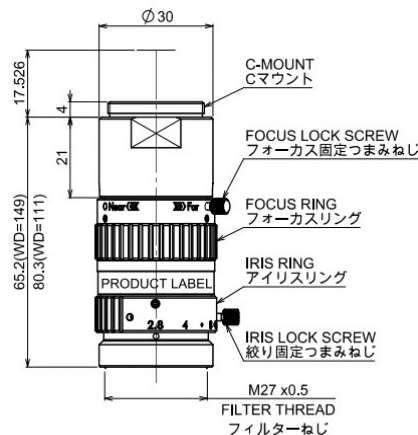

0.50x Fno2.8

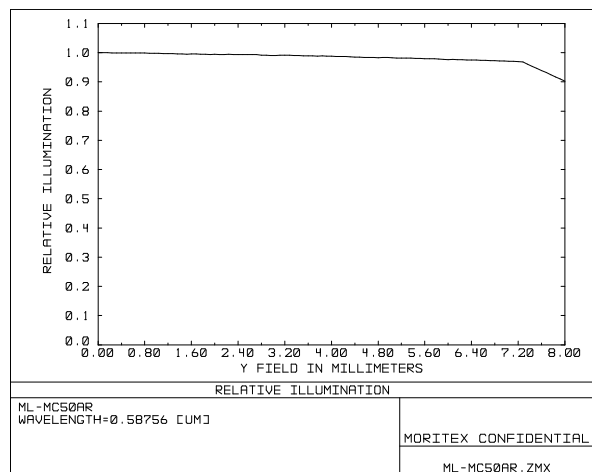
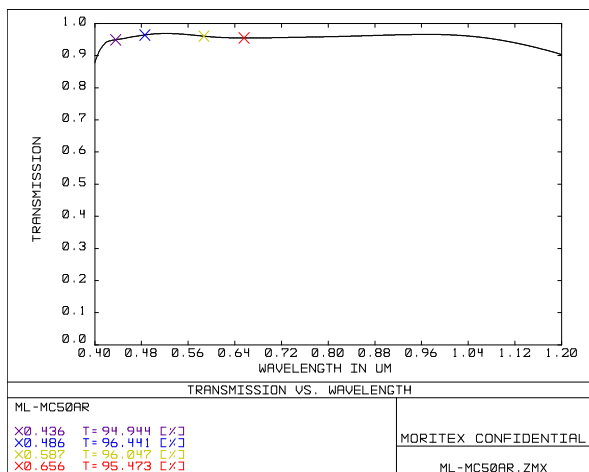
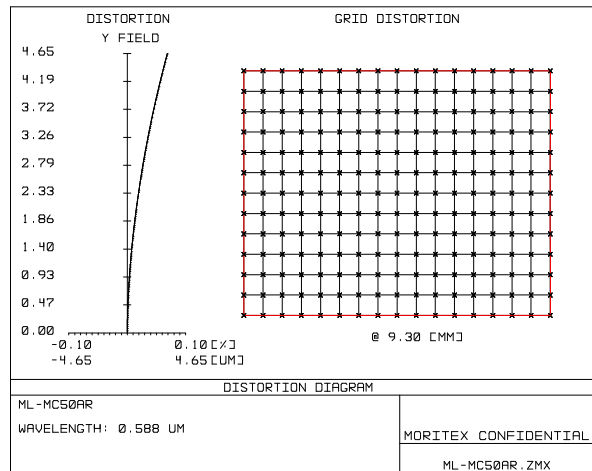
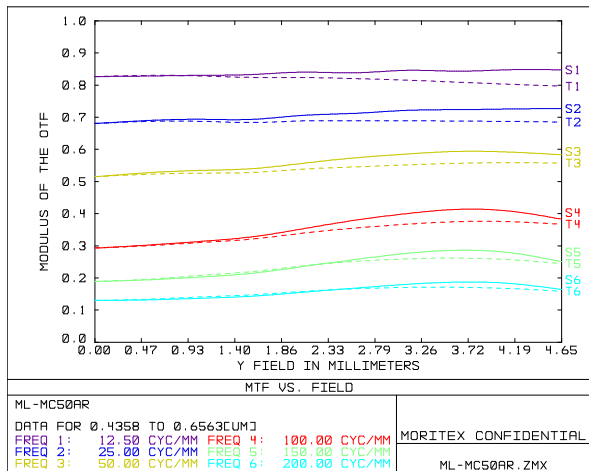

内容は、通知なしに随時変更されることがあります。

The content is subject to change at any time without notification.

株式会社 **モリテックス** MORITEX Corporation

Technology center Lens design & Development technology

moritex.mvs@moritex.com

www.moritex.com



0.80x Fno2.8

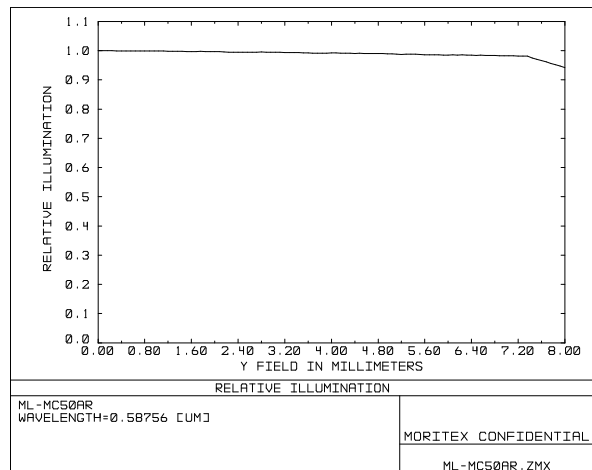
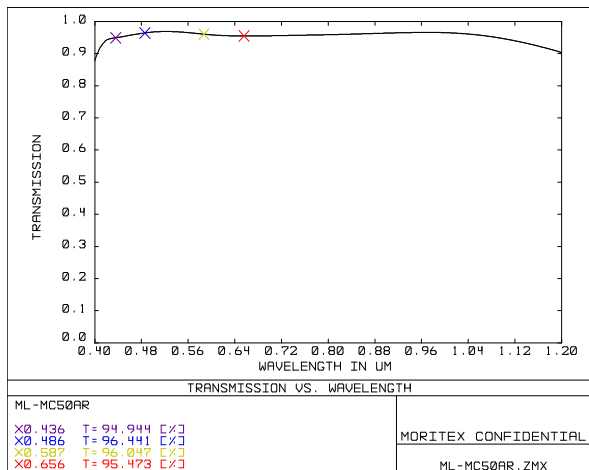
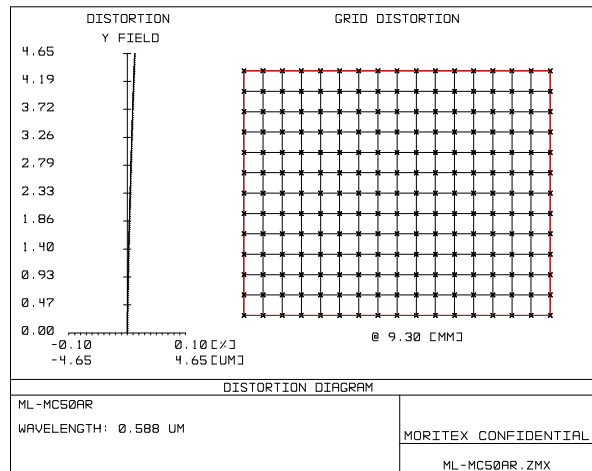
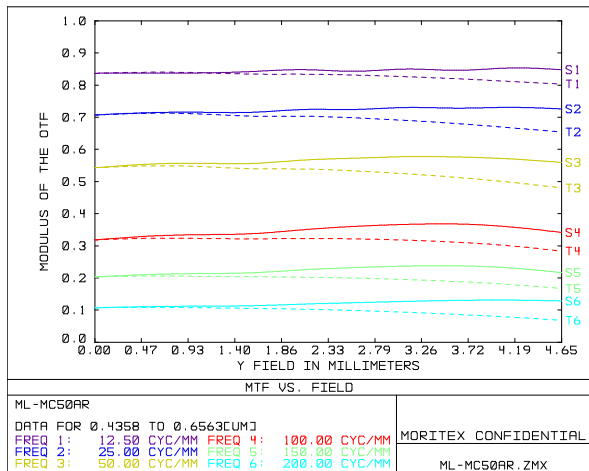

内容は、通知なしに随時変更されることがあります。

The content is subject to change at any time without notification.

株式会社 **モリテックス** MORITEX Corporation

Technology center Lens design & Development technology

moritex.mvs@moritex.com

www.moritex.com



0.50x Fno3.4

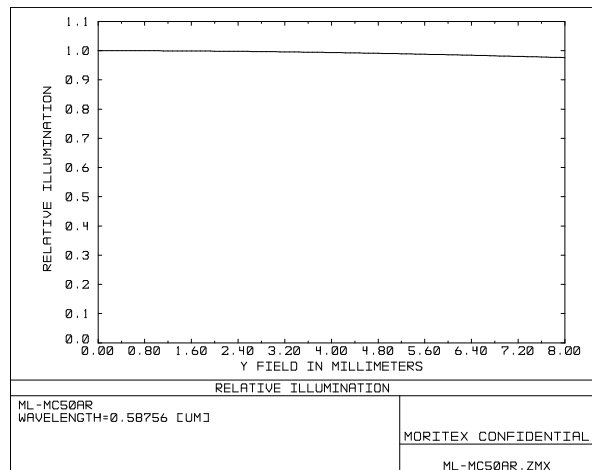
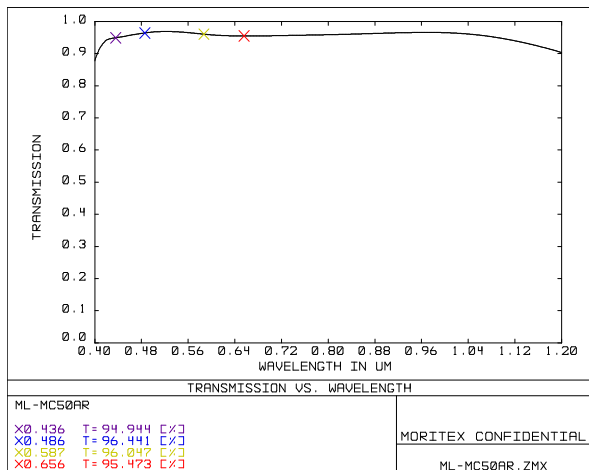
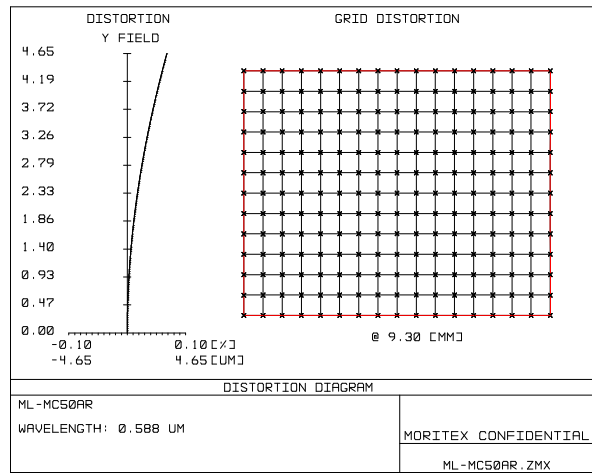
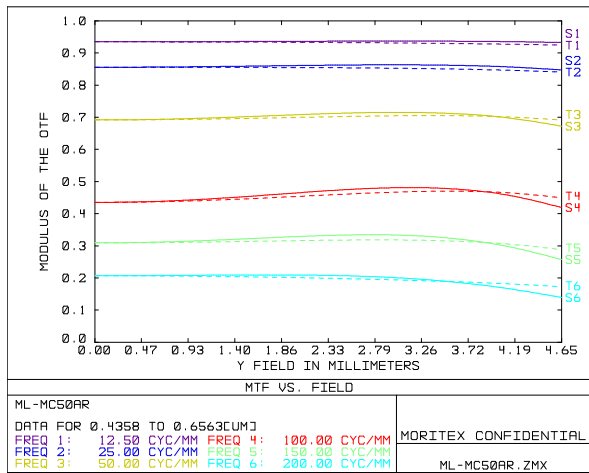

内容は、通知なしに随時変更されることがあります。

The content is subject to change at any time without notification.

株式会社 **モリテックス** MORITEX Corporation

Technology center Lens design & Development technology

moritex.mvs@moritex.com

www.moritex.com



0.80x Fno3.4

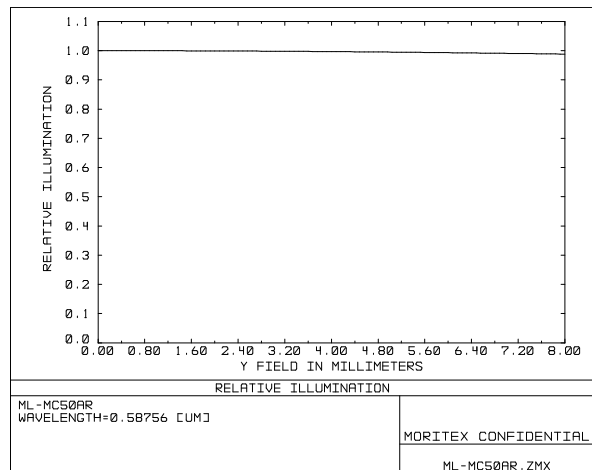
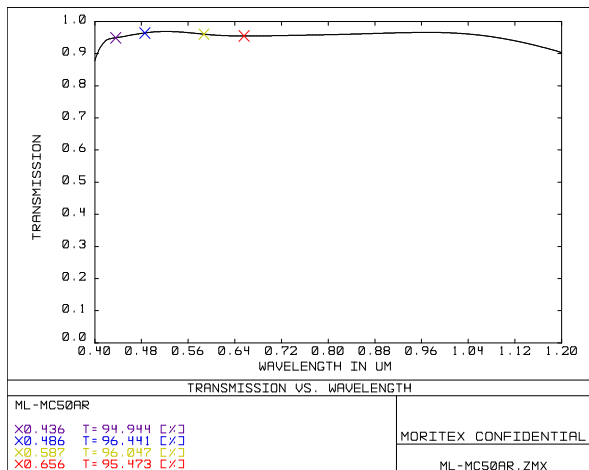
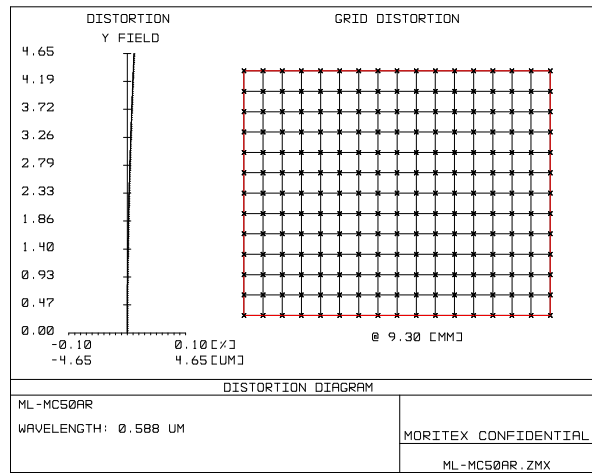
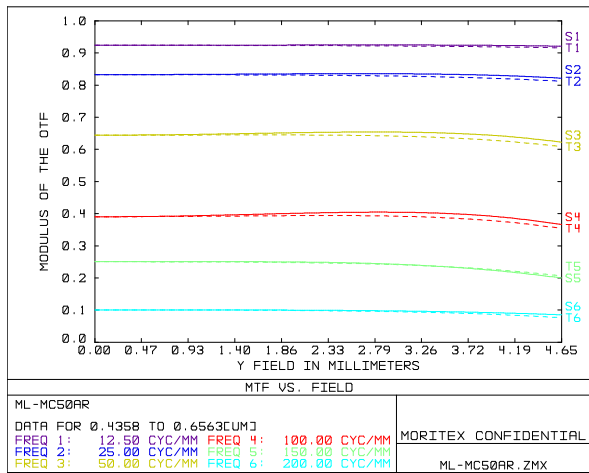

内容は、通知なしに随時変更されることがあります。

The content is subject to change at any time without notification.

株式会社 **モリテックス** MORITEX Corporation

Technology center Lens design & Development technology

moritex.mvs@moritex.com

www.moritex.com

