

ML-MC35AR

ML-MC-AR series



Drawing No. A24900

レンズ形式	Lens Type	Macro Lens
光学倍率	Magnification	0.30~0.67
焦点距離 (mm)	Focal Length	35.31
Fno	Fno	2.84~16.00
使用波長域 (nm)	Wavelength range used	400~700
NA	Numerical Aperture	-
WD/OD (mm)	Working/Object Distance	124.2~59.0 / 147.5~82.4
O/I (mm)	Object to Image Distance	196.36~144.23
鏡筒長 (mm)	Mechanical Tube Length	54.70~67.70
レンズバック (mm)	Lens Back	26.45~39.45
被写界深度 (mm)	DOF @PCoC ϕ 0.04mm	3.499~0.921
分解能 (μ m)	Resolution @ λ =550nm	-
前側/後側主点位置 (mm)	Front/Rear Principal Position	5.51 / -19.41
入射/出射瞳位置 (mm)	Entrance/Exit Pupil Position	11.25 / -14.48
入射/出射瞳径 (mm)	Entrance/Exit Pupil Diameter	12.43 / 10.69
画角 (deg.) H×V	Angle Of View @WD=124.2	5.95x4.47(1/3 Inch) 7.87x5.95(1/2 Inch) 9.05x6.92(1/1.7 Inch)
TVディストーション (%)	TV Distortion @WD=124.2	\leq 0.010(1/3 Inch) \leq 0.013(1/2 Inch) \leq 0.014(1/1.7 Inch)
周辺光量比 (%)	Relative Illumination @WD=124.2	\geq 92.36(1/3 Inch) \geq 85.36(1/2 Inch) \geq 80.59(1/1.7 Inch)
質量 (g)	Weight	91.5
マウント	Mount	C Mount
イメージサークル径 (mm)	Image Circle	ϕ 9.3
最大適合カメラ	Largest Compatible Camera	1/1.7 Inch

ML-MC35AR

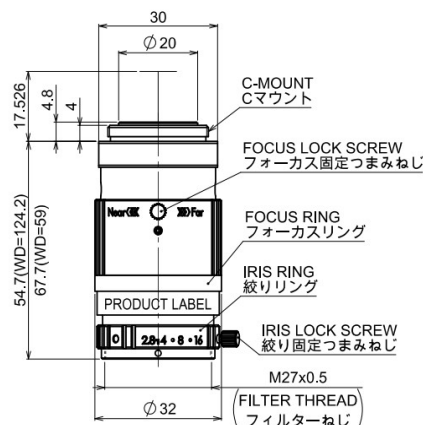

0.30x Fno2.84

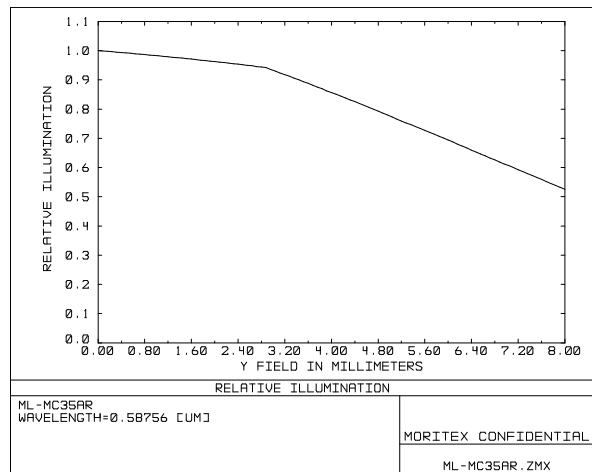
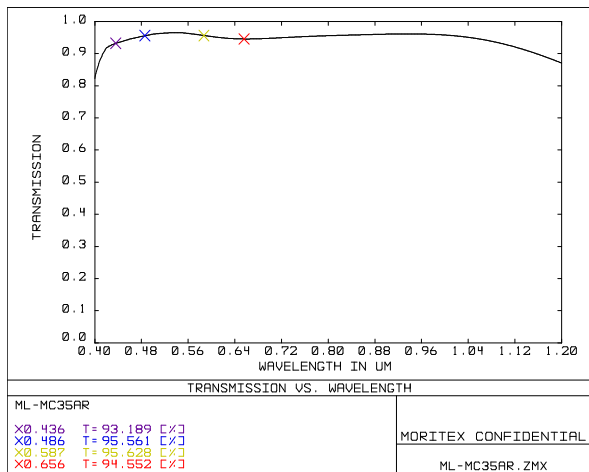
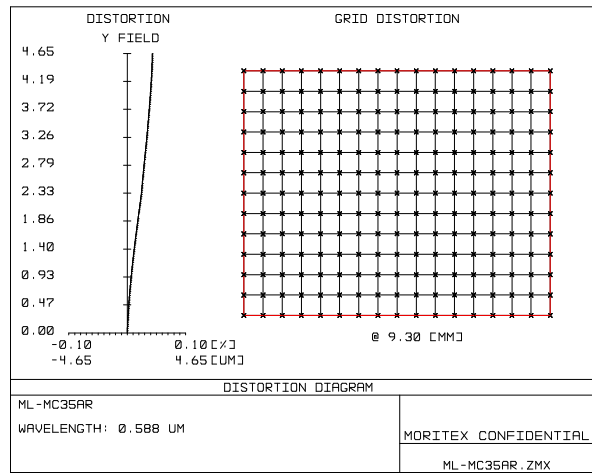
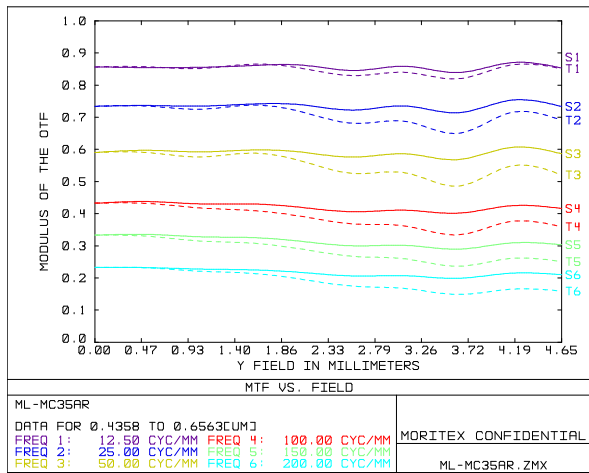

内容は、通知なしに随時変更されることがあります。

The content is subject to change at any time without notification.

株式会社 **モリテックス** MORITEX Corporation

Technology center Lens design & Development technology

moritex.mvs@moritex.com

www.moritex.com



0.67x Fno2.84

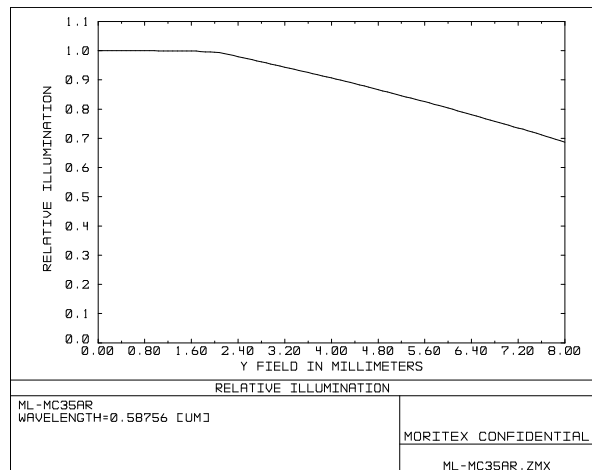
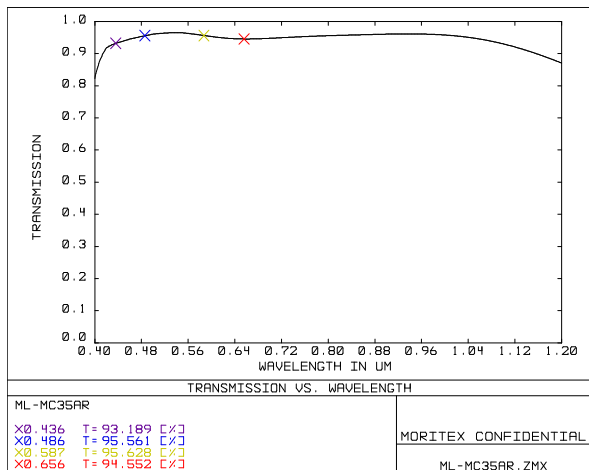
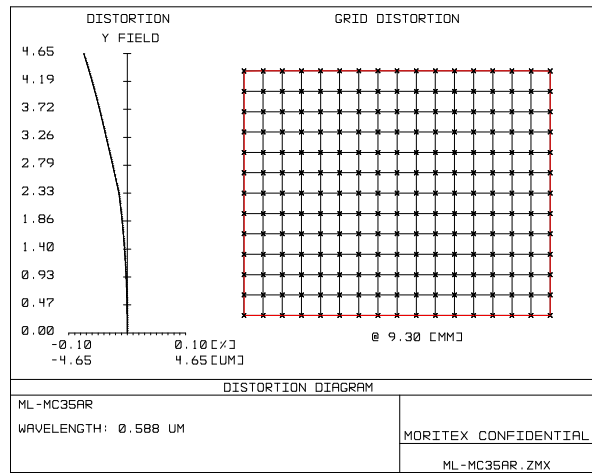
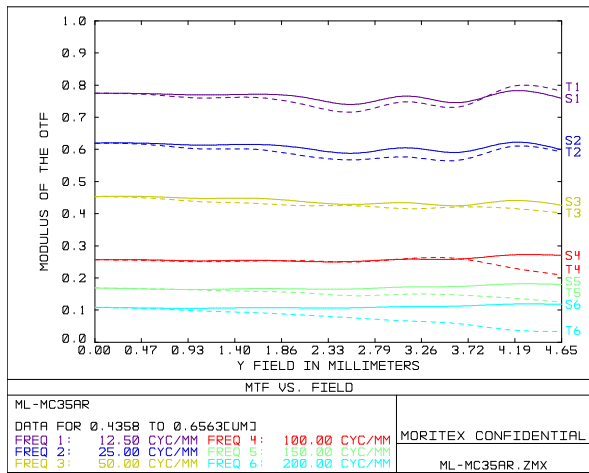

内容は、通知なしに随時変更されることがあります。

The content is subject to change at any time without notification.

株式会社 **モリテックス** MORITEX Corporation

Technology center Lens design & Development technology

moritex.mvs@moritex.com

www.moritex.com



0.485x Fno2.84

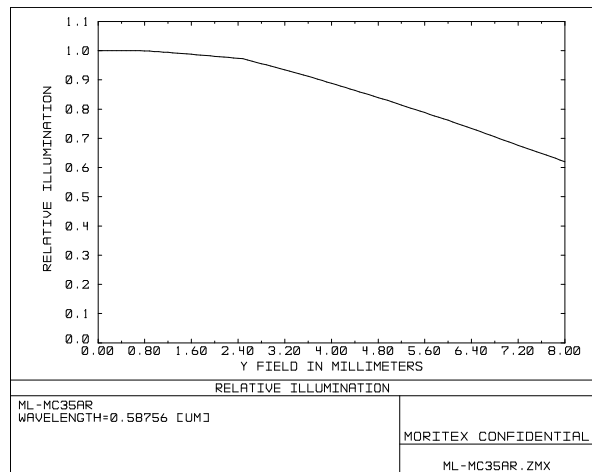
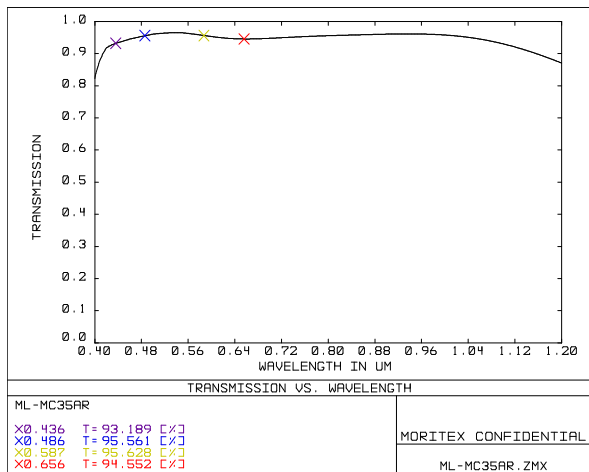
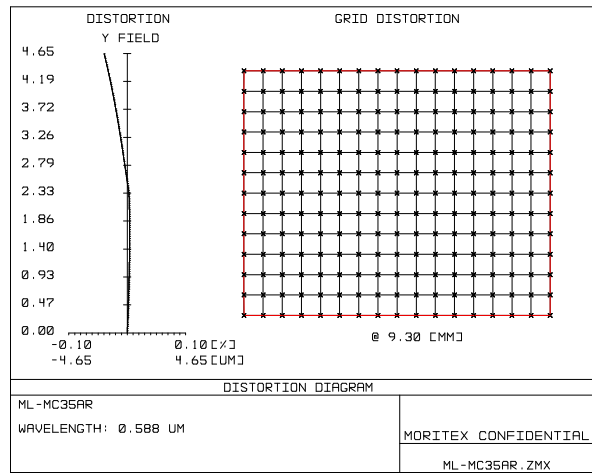
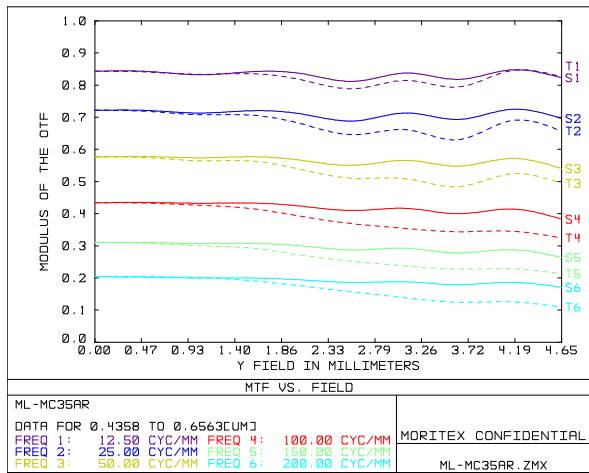

内容は、通知なしに随時変更されることがあります。

The content is subject to change at any time without notification.

株式会社 **モリテックス** MORITEX Corporation

Technology center Lens design & Development technology

moritex.mvs@moritex.com

www.moritex.com



0.30x Fno3.6

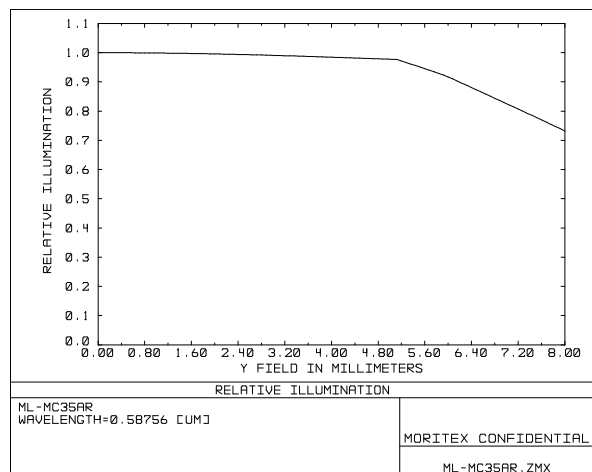
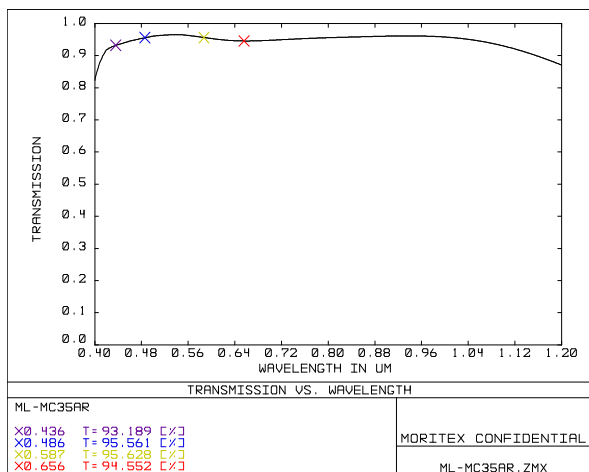
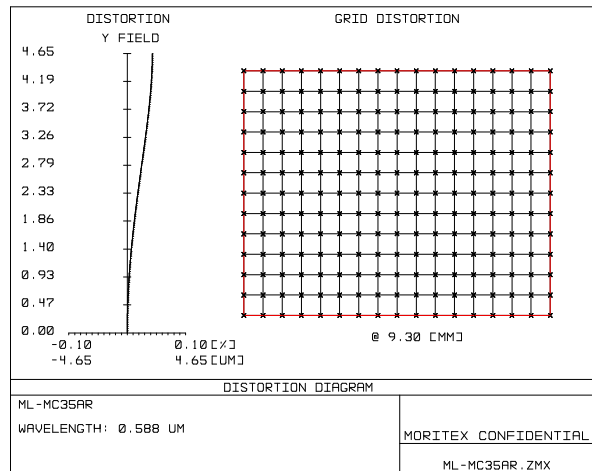
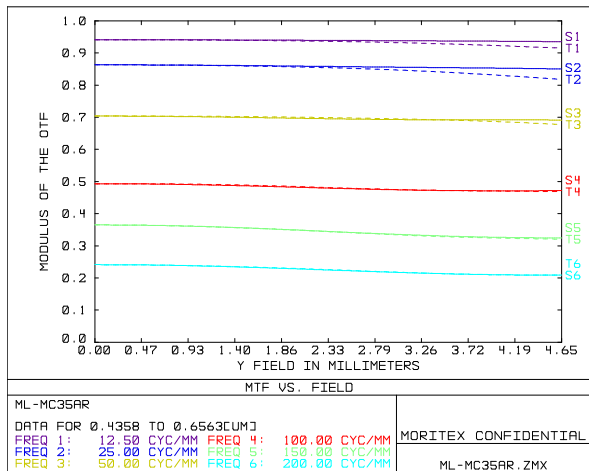

内容は、通知なしに随時変更されることがあります。

The content is subject to change at any time without notification.

株式会社 **モリテックス** MORITEX Corporation

Technology center Lens design & Development technology

moritex.mvs@moritex.com

www.moritex.com



0.67x Fno3.6

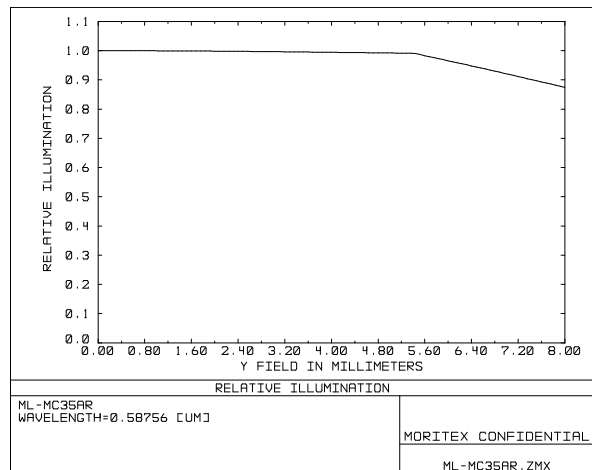
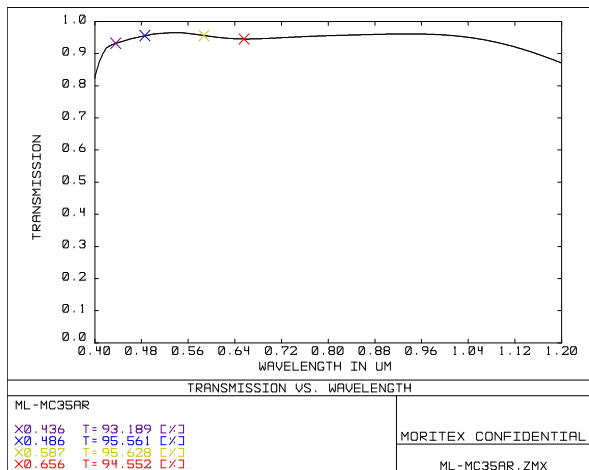
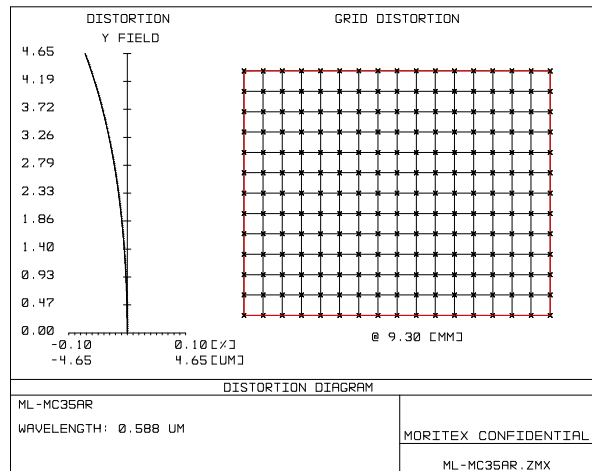
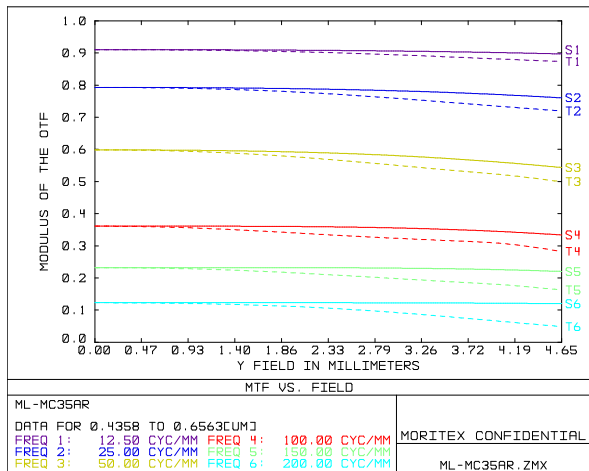

内容は、通知なしに随時変更されることがあります。

The content is subject to change at any time without notification.

株式会社 **モリテックス** MORITEX Corporation

Technology center Lens design & Development technology

moritex.mvs@moritex.com

www.moritex.com



0.485x Fno3.6

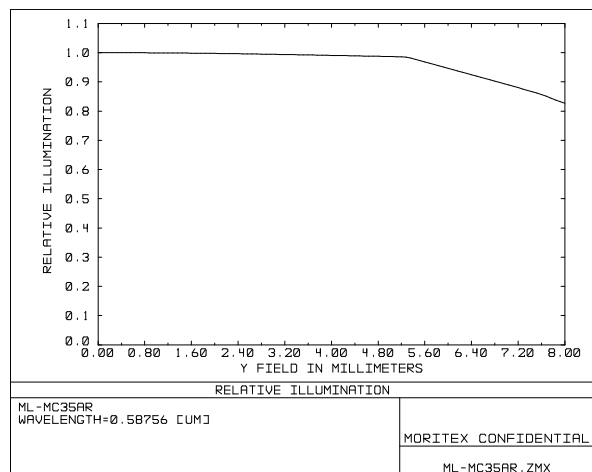
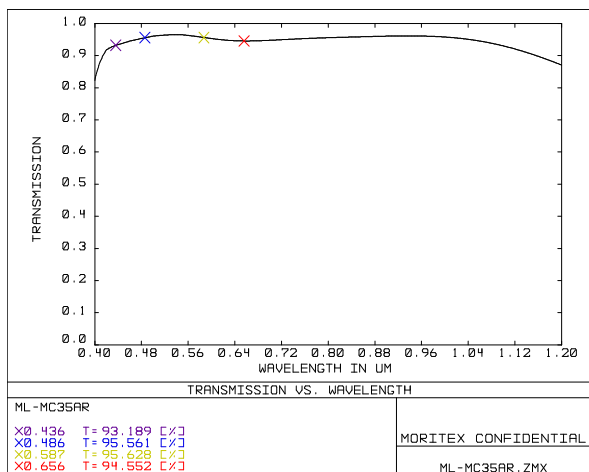
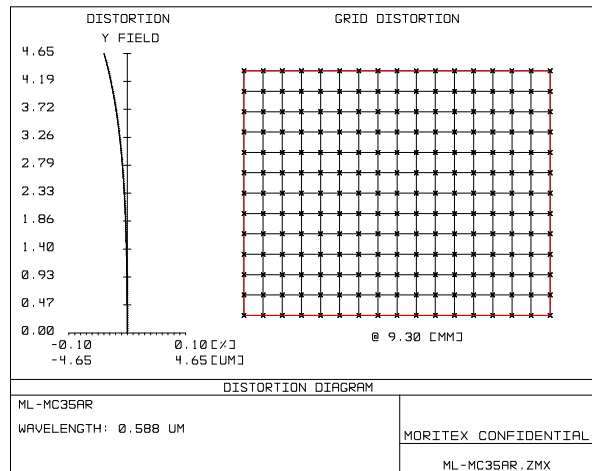
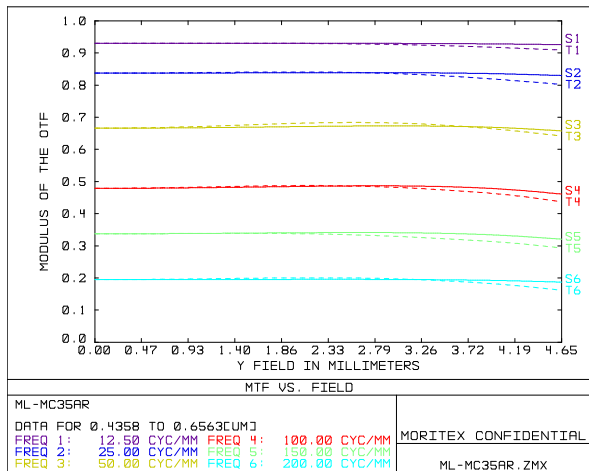

内容は、通知なしに随時変更されることがあります。

The content is subject to change at any time without notification.

株式会社 **モリテックス** MORITEX Corporation

Technology center Lens design & Development technology

moritex.mvs@moritex.com

www.moritex.com

