

# ML-MC25AR

## ML-MC-AR series



Drawing No. A24885

レンズ形式	Lens Type	Macro Lens
光学倍率	Magnification	0.10~0.40
焦点距離 (mm)	Focal Length	25.03
Fno	Fno	2.70~16.00
使用波長域 (nm)	Wavelength range used	400~700
NA	Numerical Aperture	-
WD/OD (mm)	Working/Object Distance	252.9~65.2 / 272.6~84.9
O/I (mm)	Object to Image Distance	303.48~123.18
鏡筒長 (mm)	Mechanical Tube Length	33.00~40.50
レンズバック (mm)	Lens Back	17.94~25.37
被写界深度 (mm)	DOF @PCoC $\phi$ 0.04mm	24.816~2.064
分解能 ( $\mu$ m)	Resolution @ $\lambda$ =550nm	-
前側/後側主点位置 (mm)	Front/Rear Principal Position	2.70 / -9.59
入射/出射瞳位置 (mm)	Entrance/Exit Pupil Position	10.40 / -3.70
入射/出射瞳径 (mm)	Entrance/Exit Pupil Diameter	9.28 / 7.09
画角 (deg.) H×V	Angle Of View @WD=252.9	9.72x7.23(1/3 Inch) 12.93x9.70(1/2 Inch) 15.02x11.28(1/1.7 Inch)
TVディストーション (%)	TV Distortion @WD=252.9	$\leq$ 0.015(1/3 Inch) $\leq$ 0.024(1/2 Inch) $\leq$ 0.029(1/1.7 Inch)
周辺光量比 (%)	Relative Illumination @WD=252.9	$\geq$ 94.91(1/3 Inch) $\geq$ 91.44(1/2 Inch) $\geq$ 72.97(1/1.7 Inch)
質量 (g)	Weight	64.0
マウント	Mount	C Mount
イメージサークル径 (mm)	Image Circle	$\phi$ 9.3
最大適合カメラ	Largest Compatible Camera	1/1.7 Inch

### ML-MC25AR

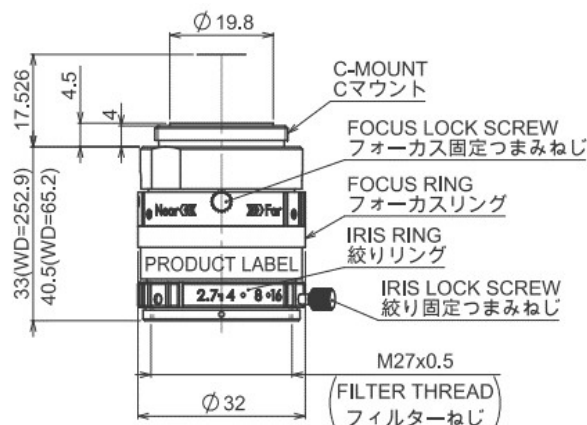

### 0.10x Fno2.7

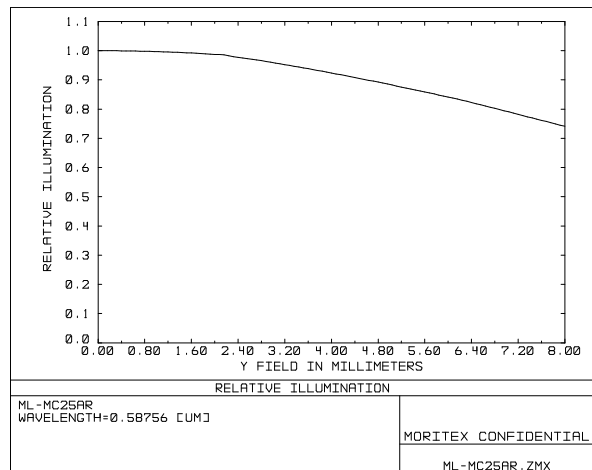
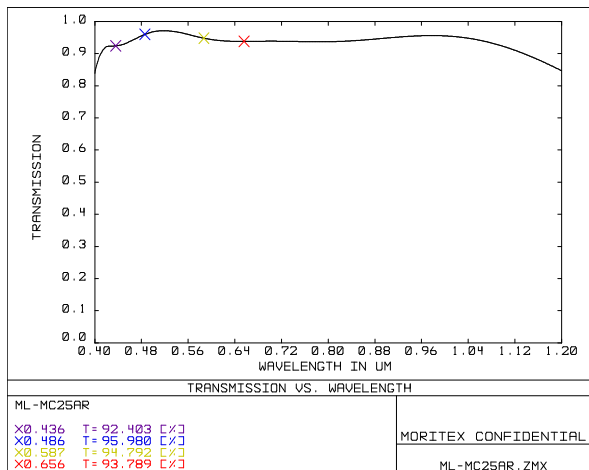
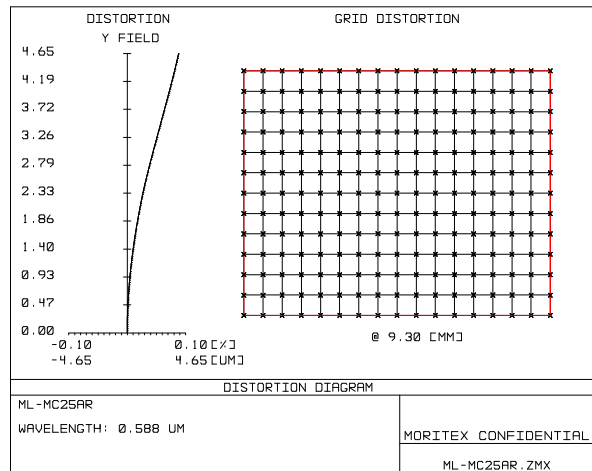
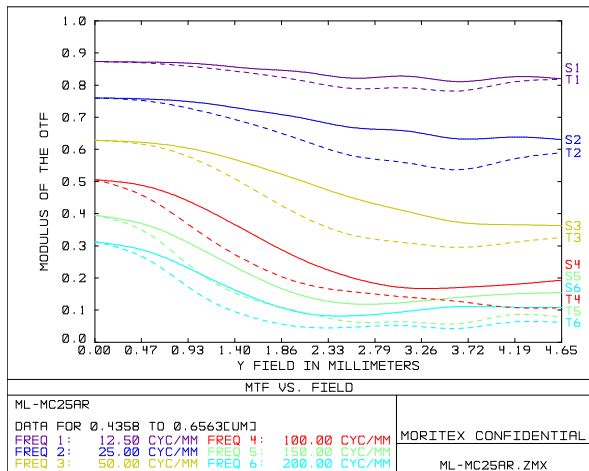

内容は、通知なしに随時変更されることがあります。

The content is subject to change at any time without notification.

株式会社 **モリテックス** MORITEX Corporation

Technology center Lens design & Development technology

moritex.mvs@moritex.com

www.moritex.com



## 0.40x Fno2.7

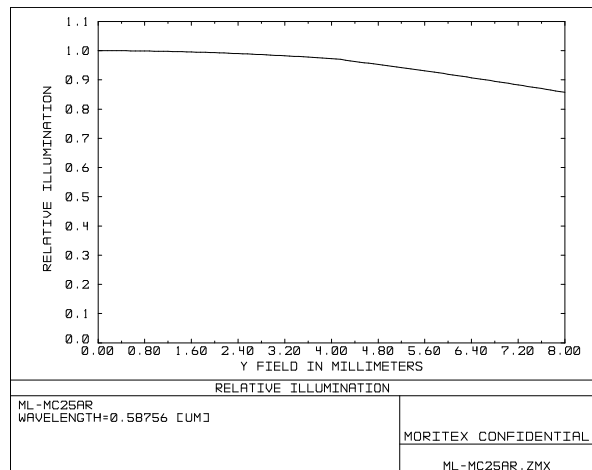
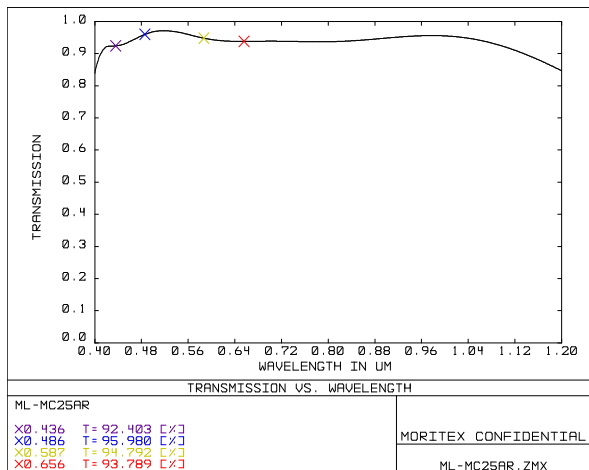
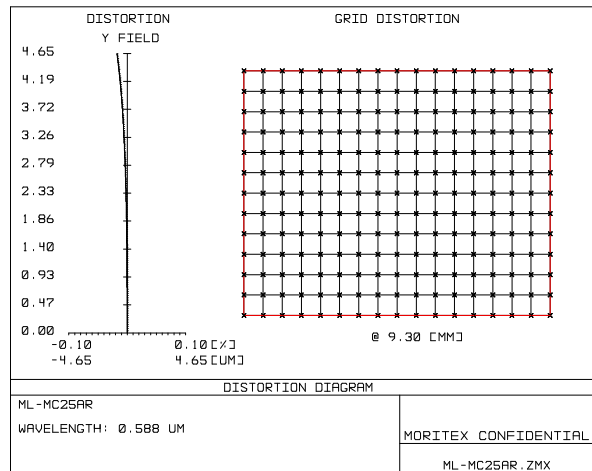
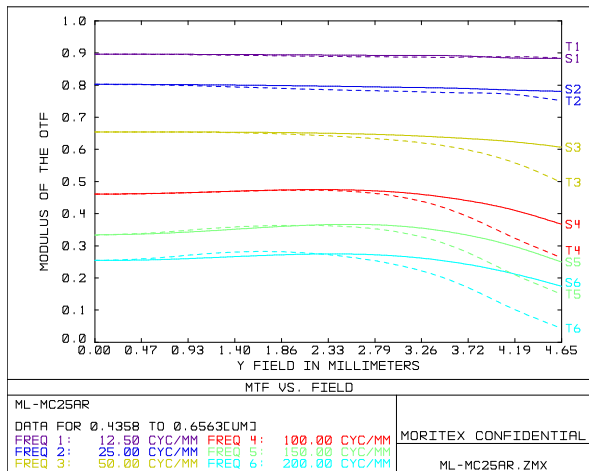

内容は、通知なしに随時変更されることがあります。

The content is subject to change at any time without notification.

株式会社 **モリテックス** MORITEX Corporation

Technology center Lens design & Development technology

moritex.mvs@moritex.com

www.moritex.com



## 0.20x Fno2.7

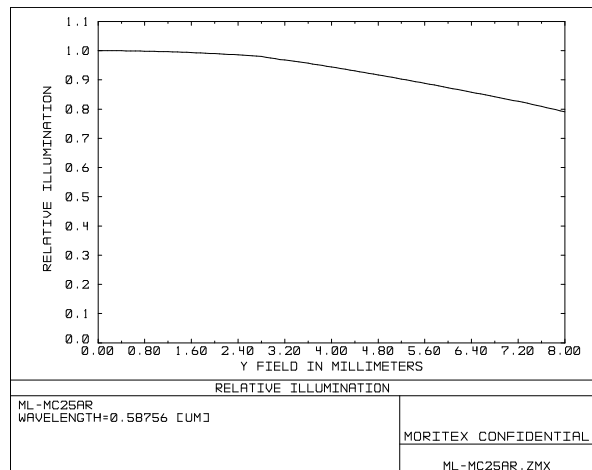
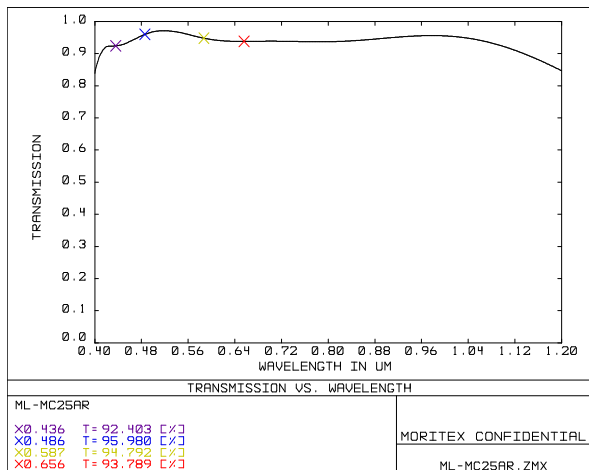
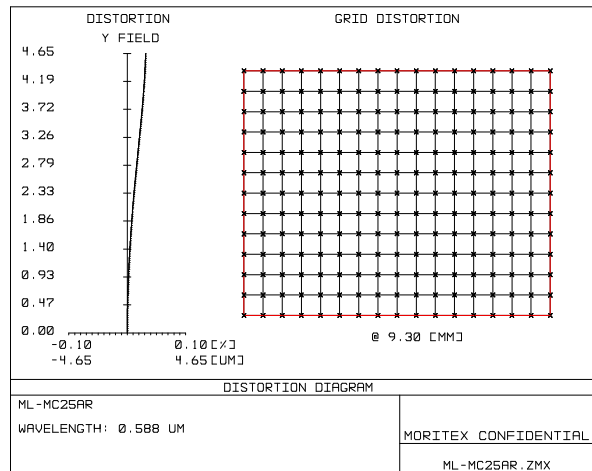
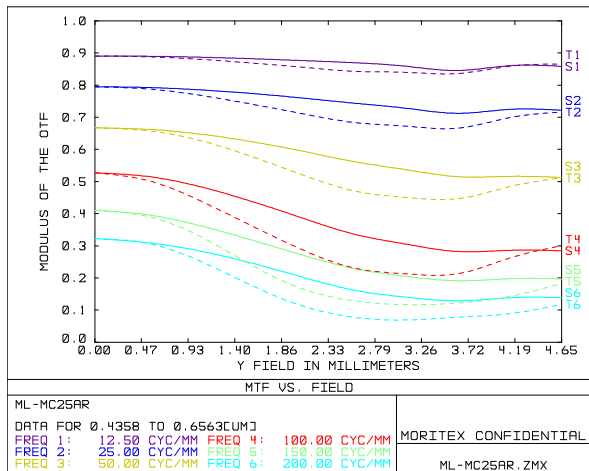

内容は、通知なしに随時変更されることがあります。

The content is subject to change at any time without notification.

株式会社 **モリテックス** MORITEX Corporation

Technology center Lens design & Development technology

moritex.mvs@moritex.com

www.moritex.com



### 0.10x Fno3.8

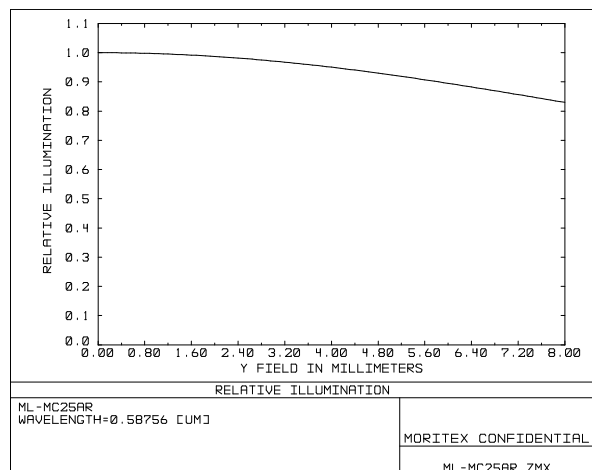
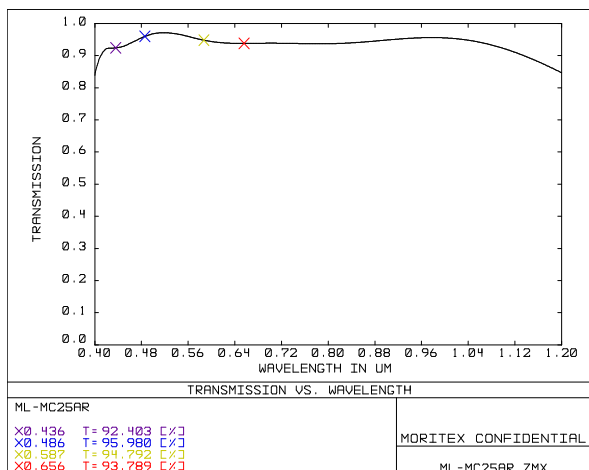
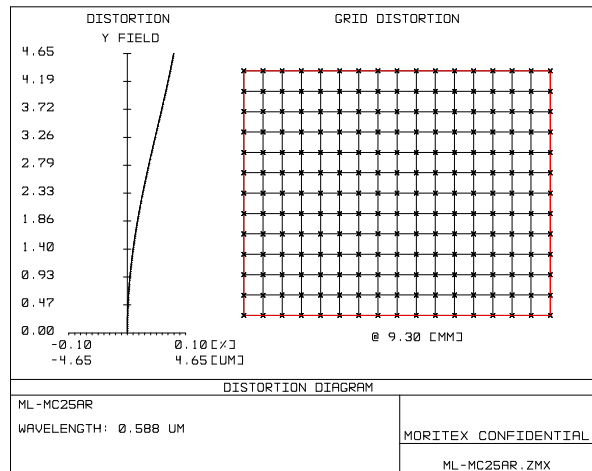
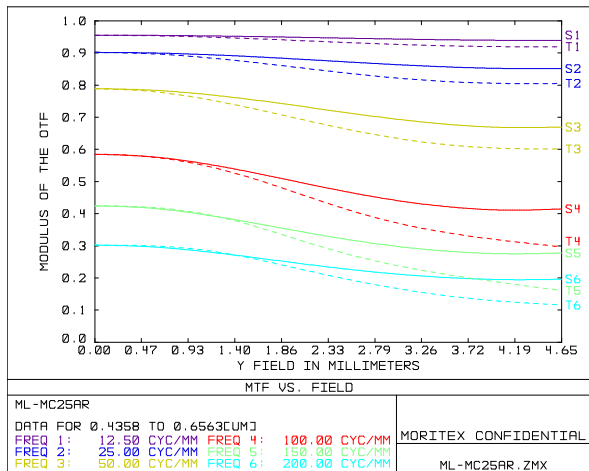

内容は、通知なしに随時変更されることがあります。

The content is subject to change at any time without notification.

株式会社 **モリテックス** MORITEX Corporation

Technology center Lens design & Development technology

moritex.mvs@moritex.com

www.moritex.com



### 0.40x Fno3.8

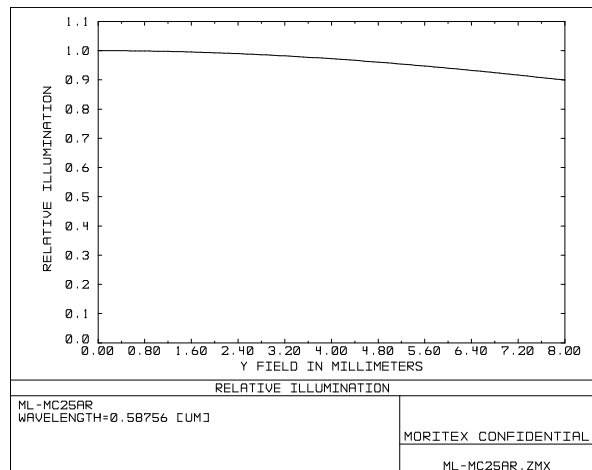
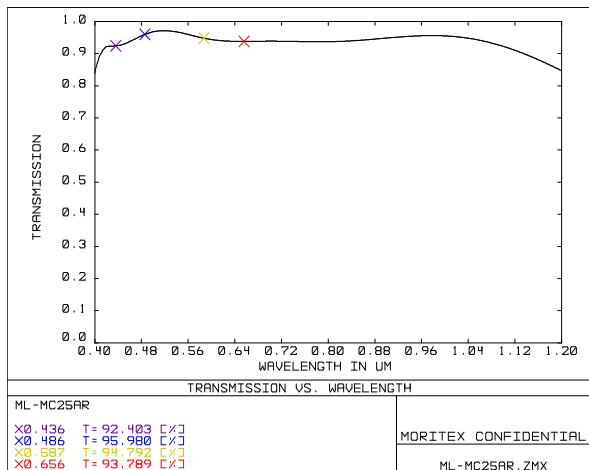
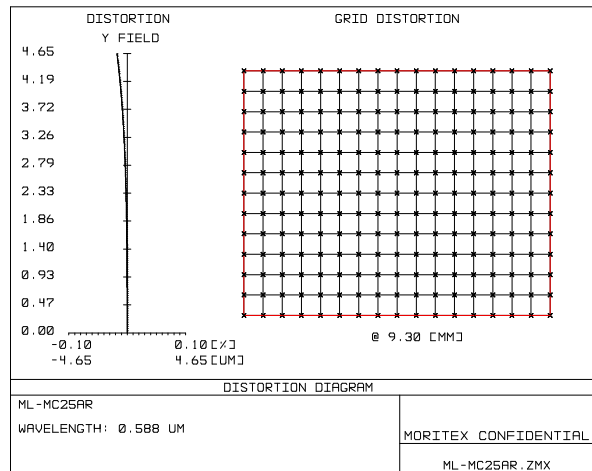
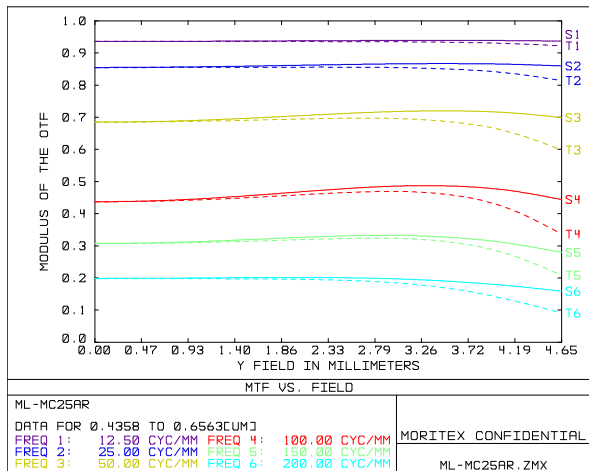

内容は、通知なしに随時変更されることがあります。

The content is subject to change at any time without notification.

株式会社 **モリテックス** MORITEX Corporation

Technology center Lens design & Development technology

moritex.mvs@moritex.com

www.moritex.com



## 0.20x Fno3.8

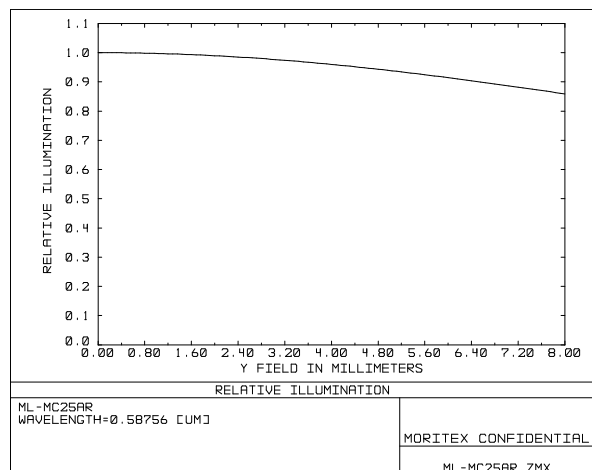
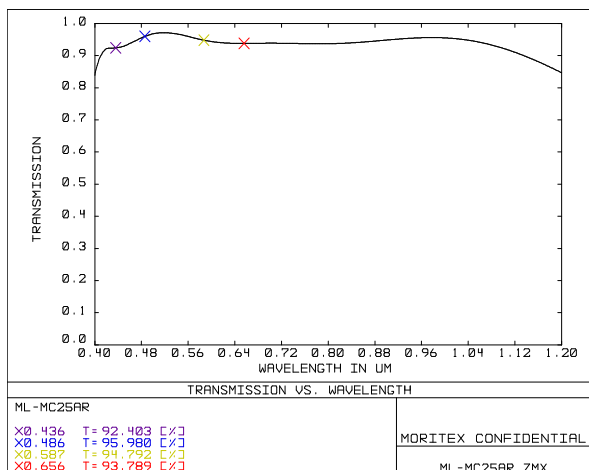
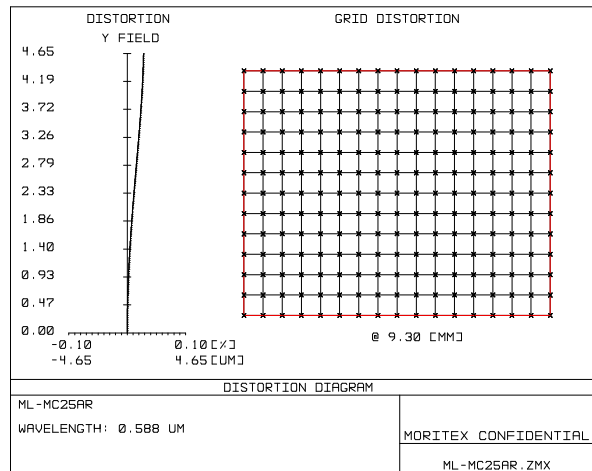
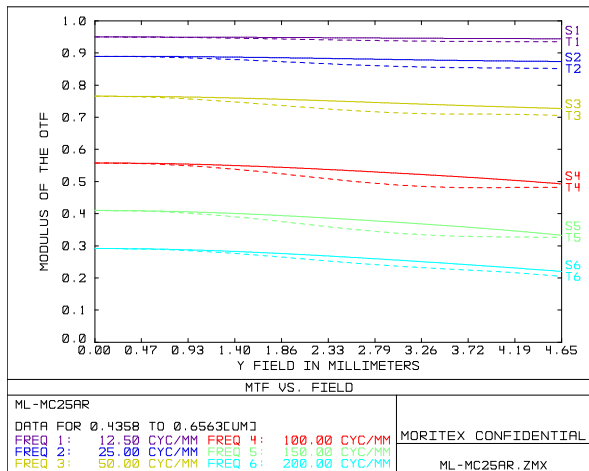

内容は、通知なしに随時変更されることがあります。

The content is subject to change at any time without notification.

株式会社 **モリテックス** MORITEX Corporation

Technology center Lens design & Development technology

moritex.mvs@moritex.com

www.moritex.com

