

# ML-MC2540BR-16C-G

## ML-BR-G series

Drawing No. A24376



レンズ形式	Lens Type	Macro Lens
光学倍率	Magnification	0.04~0.12
焦点距離 (mm)	Focal Length	25.00
Fno	Fno	4.00
NA	Numerical Aperture	-
WD/OD (mm)	Working/Object Distance	700.0~200.0 / 710.0~210.0
O/I (mm)	Object to Image Distance	747.57~249.74
鏡筒長 (mm)	Mechanical Tube Length	34.20~36.40
レンズバック (mm)	Lens Back	12.47~14.64
被写界深度 (mm)	DOF @PCoC $\phi$ 0.04mm	262.646~23.751
分解能 ( $\mu$ m)	Resolution @ $\lambda$ =550nm	-
前側/後側主点位置 (mm)	Front/Rear Principal Position	19.93 / -13.38
入射/出射瞳位置 (mm)	Entrance/Exit Pupil Position	15.91 / -18.18
入射/出射瞳径 (mm)	Entrance/Exit Pupil Diameter	6.25 / 7.45
画角 (deg.) H×V	Angle Of View @WD=700	14.17 × 10.65(1/2 Inch) 19.40 × 14.61(2/3 Inch) 28.58 × 21.64(1 Inch)
TVディストーション (%)	TV Distortion @WD=700	$\leq$ 0.020(1/2 Inch) $\leq$ 0.037(2/3 Inch) $\leq$ 0.078(1Inch)
周辺光量比 (%)	Relative Illumination @WD=700	$\geq$ 95.13(1/2 Inch) $\geq$ 91.06(2/3 Inch) $\geq$ 55.74(1Inch)
質量 (g)	Weight	44.4
マウント	Mount	C Mount
イメージサークル径 (mm)	Image Circle	$\phi$ 16.4
最大適合カメラ	Largest Compatible Camera	1 Inch

### ML-MC2540BR-16C-G

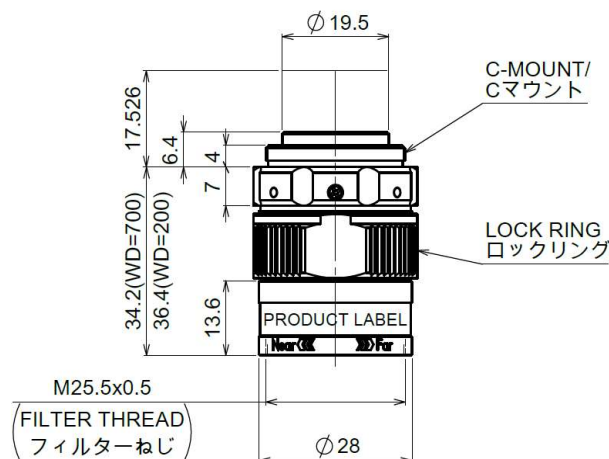

## 0.04x Fno4.0

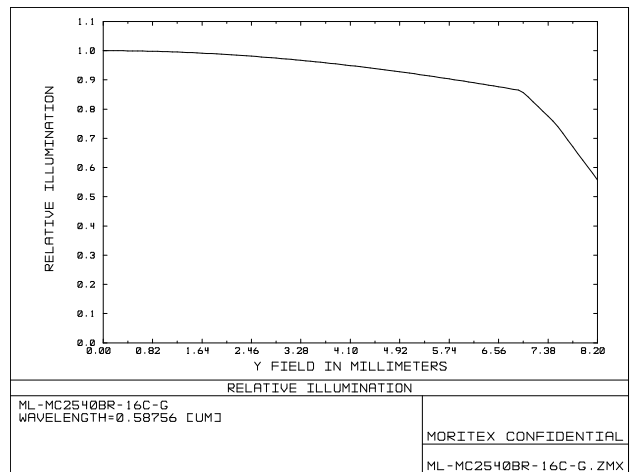
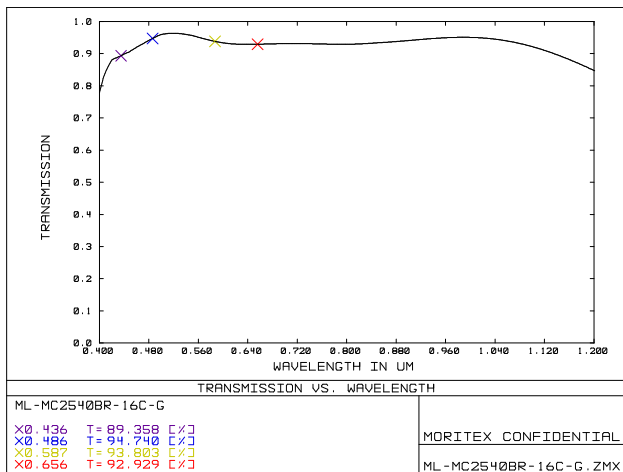
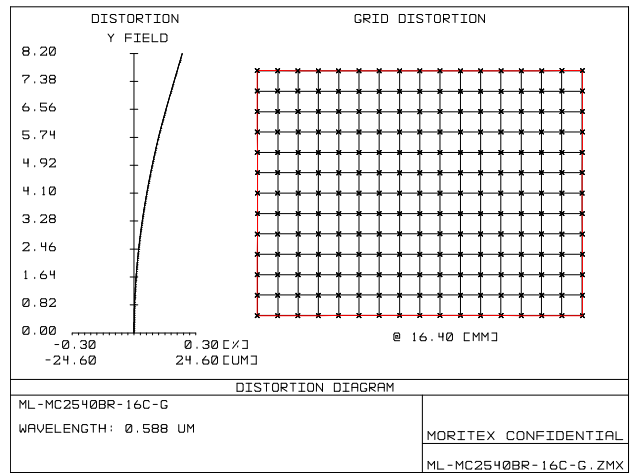
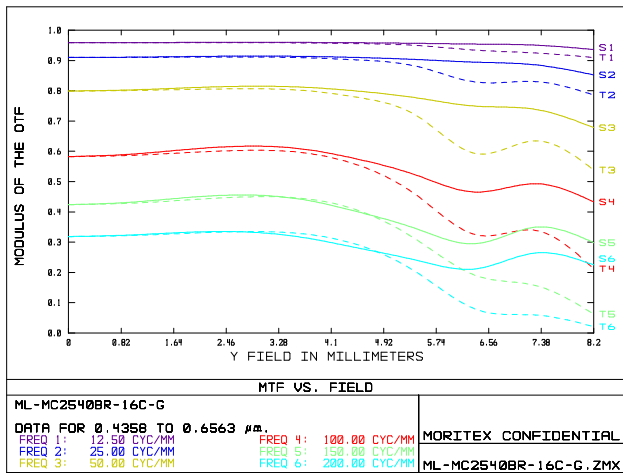

内容は、通知なしに随時変更されることがあります。

The content is subject to change at any time without notification.

株式会社 **モリテックス** MORITEX Corporation

Technology center Lens design & Development technology

TEL +81 (0)45-913-5800 moritex.mvs@moritex.com

www.moritex.com



# 0.07x Fno4.0

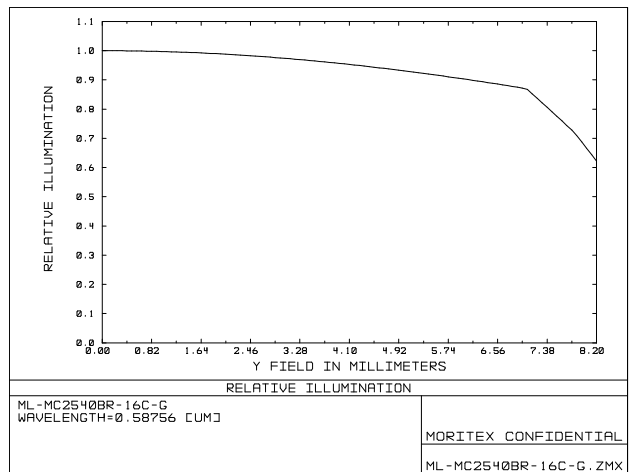
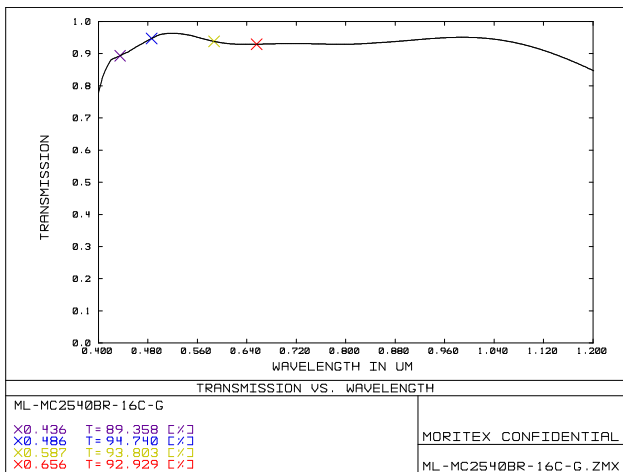
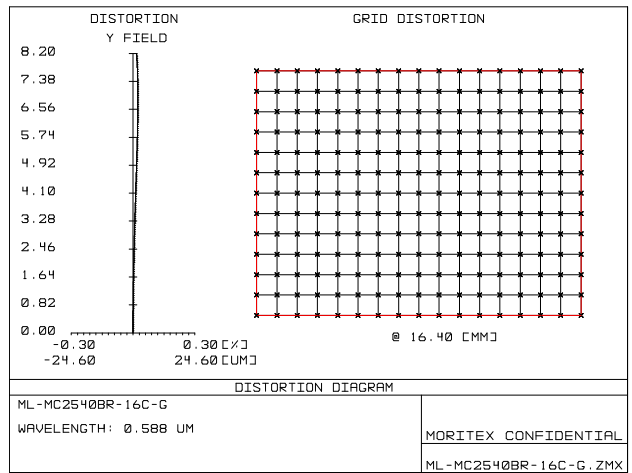
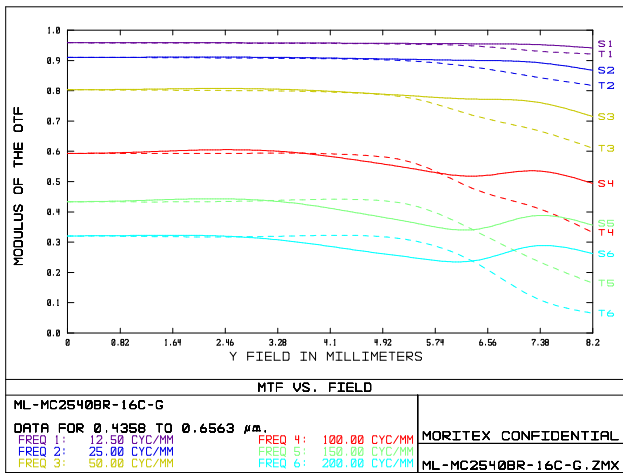

内容は、通知なしに随時変更されることがあります。

The content is subject to change at any time without notification.

株式会社 **モリテックス** MORITEX Corporation

Technology center Lens design & Development technology

TEL +81 (0)45-913-5800 moritex.mvs@moritex.com

www.moritex.com



## 0.12x Fno4.0

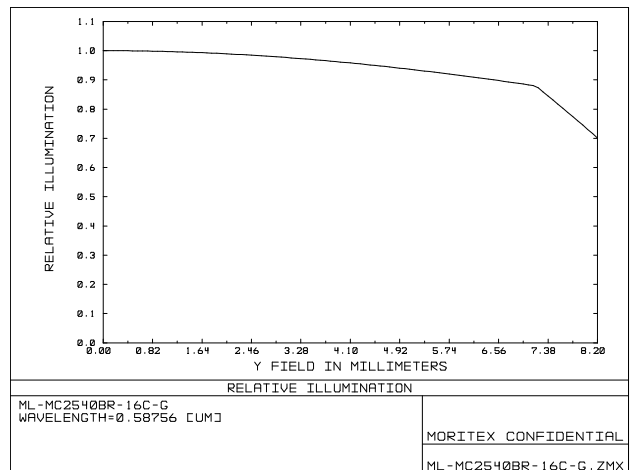
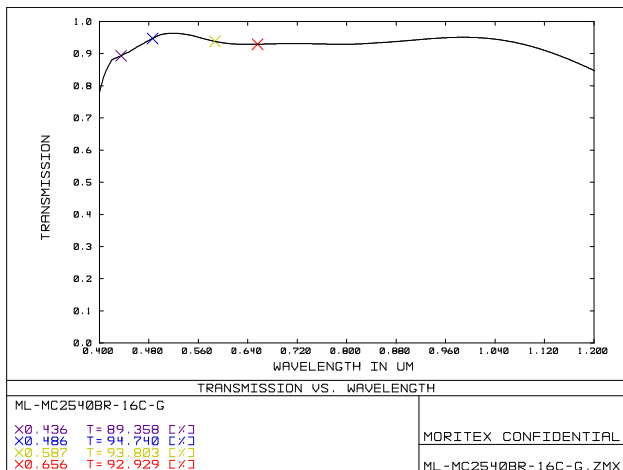
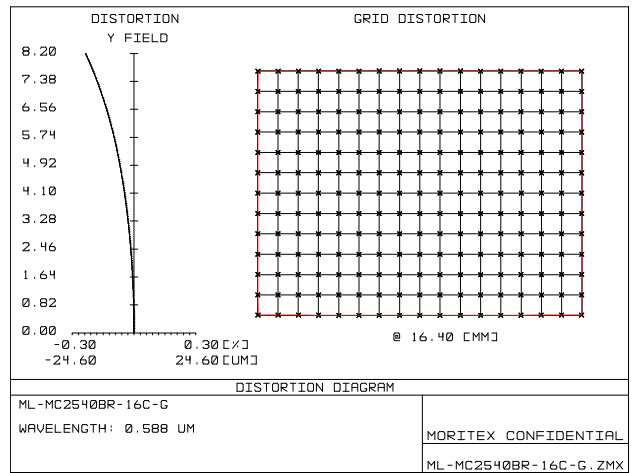
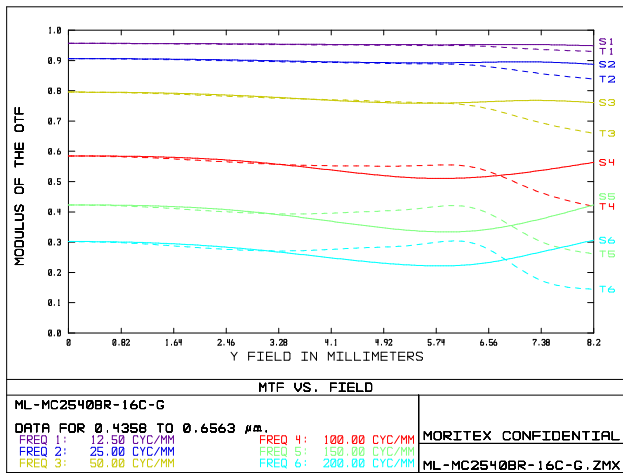

内容は、通知なしに随時変更されることがあります。

The content is subject to change at any time without notification.

株式会社 **モリテックス** MORITEX Corporation

Technology center Lens design & Development technology

TEL +81 (0)45-913-5800 moritex.mvs@moritex.com

www.moritex.com

