

ML-U1217SR-18C

ML-U-SR series



Drawing No. A23499

		Lens Type	CCTV Lens	
		Focus Position	Reference Magnification	M.O.D
		Magnification	0.030	0.110
	(mm)	Focal Length	12.31	12.76
Fno		Fno	1.70	16.00
NA		Numerical Aperture	-	-
WD/OD (mm)		Working/Object Distance	400 / 403.0	100.0 / 103.0
O/I (mm)		Object to Image Distance	483.76	183.76
	(mm)	Mechanical Tube Length	65.50	
	(mm)	Lens Back	13.55	15.10
	(mm)	DOF @PCoC 0.04mm	178.687	13.608
	(μ m)	Resolution @ $\lambda=550$ nm	-	-
/	(mm)	Front/Rear Principal Position	25.83 / 0.89	25.87 / 0.93
/	(mm)	Entrance/Exit Pupil Position	16.10 / -45.67	15.86 / -45.67
/	(mm)	Entrance/Exit Pupil Diameter	6.71 / 32.11	6.90 / 32.11
(deg.)	H x V	Angle Of View	61.62 x 47.42	58.80 x 45.11
TV	(%)	TV Distortion	-1.958	-2.136
	(%)	Relative Illumination	33.85	41.12
	(g)	Weight	200.0	
		Mount	C mount	
	(mm)	Image Circle	17.6	
		Largest Compatible Camera	1.1 Inch	

ML-U1217SR-18C

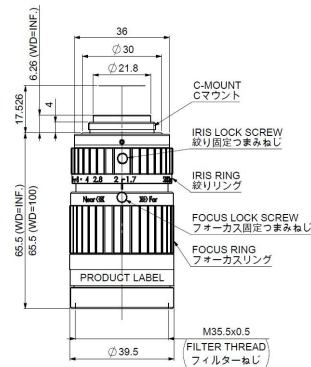

WD=400.0mm Fno2.8

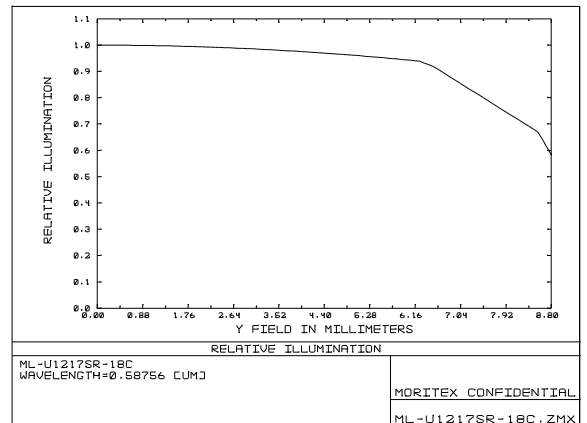
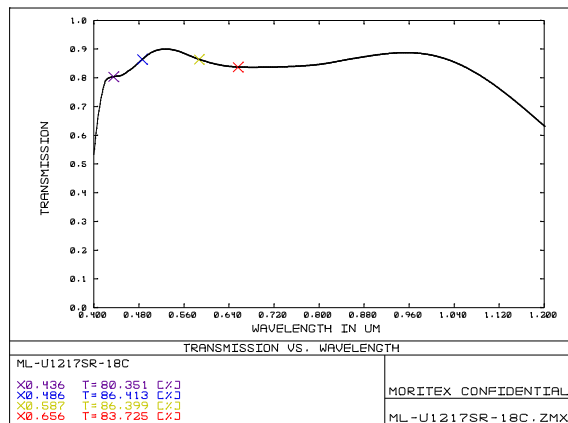
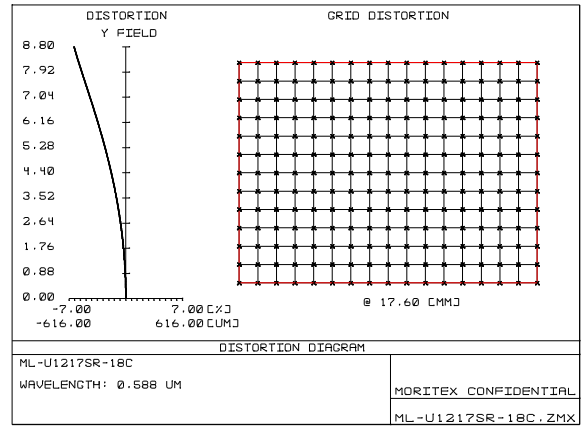
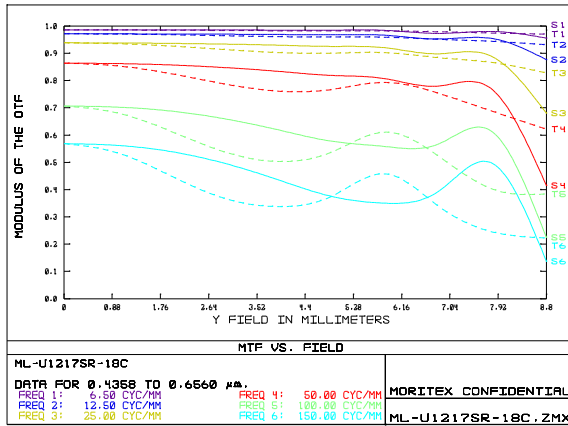

The content is subject to change at any time without notification.

株式会社 **モリテックス** MORITEX Corporation

Technology center Lens design & Development technology

TEL +81 (0)48-218-2536 moritex.mvs@moritex.com

FAX +81 (0)48-462-6713 www.moritex.com



WD=100.0mm Fno2.8

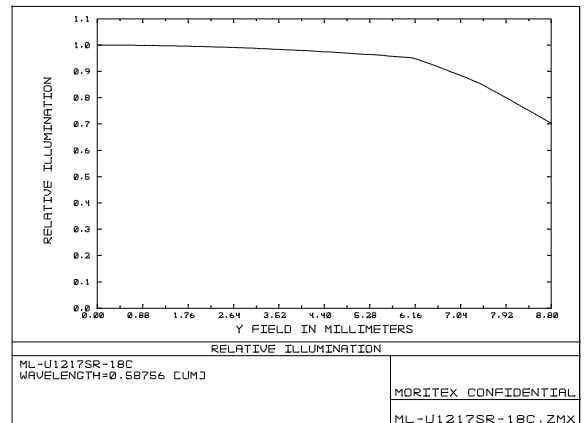
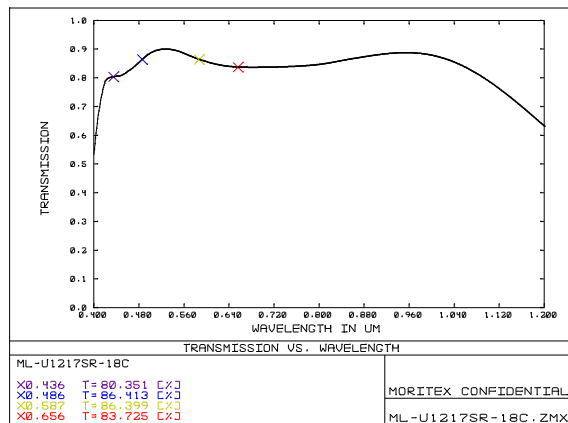
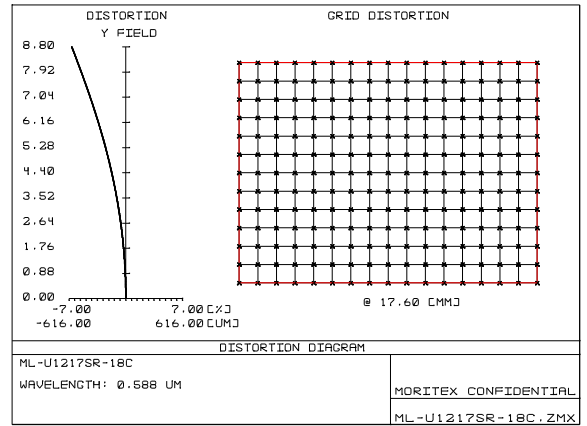
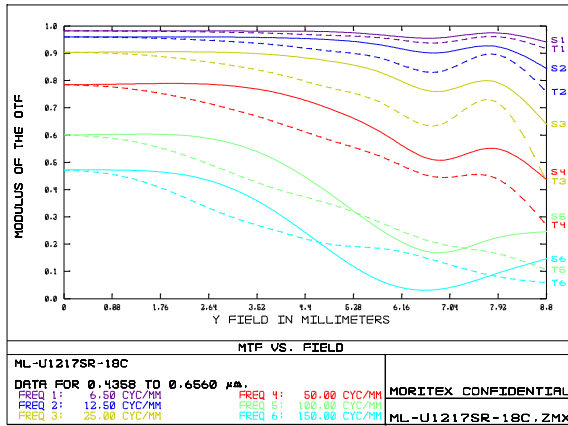

The content is subject to change at any time without notification.

株式会社 **モリテックス** MORITEX Corporation

Technology center Lens design & Development technology

TEL +81 (0)48-218-2536 moritex.mvs@moritex.com

FAX +81 (0)48-462-6713 www.moritex.com

