

ML-M5025UR

ML-M-UR series



Drawing No. A23071

		Lens Type	CCTV Lens	
		Focus Position	Reference Magnification	M.O.D
		Magnification	0.106	0.194
	(mm)	Focal Length	49.98	52.92
Fno		Fno	2.50	16.00
NA		Numerical Aperture	-	-
WD/OD (mm)		Working/Object Distance	500.0 / 506.5	300.0 / 306.5
O/I (mm)		Object to Image Distance	567.24	372.96
	(mm)	Mechanical Tube Length	46.80	59.40
	(mm)	Lens Back	12.06	12.06
	(mm)	DOF @PCoC 0.04mm	19.809	6.713
	(μ m)	Resolution @ $\lambda=550$ nm	-	-
/	(mm)	Front/Rear Principal Position	13.98 / -43.21	18.65 / -51.12
/	(mm)	Entrance/Exit Pupil Position	21.20 / -36.90	21.20 / -48.69
/	(mm)	Entrance/Exit Pupil Diameter	20.77 / 18.15	20.77 / 19.82
(deg.)	H x V	Angle Of View	9.03 x 6.74	7.91 x 5.93
TV	(%)	TV Distortion	-0.010	-0.021
	(%)	Relative Illumination	76.71	77.66
	(g)	Weight	70	
		Mount	C mount	
	(mm)	Image Circle	11	
		Largest Compatible Camera	2/3 Inch	

ML-M5025UR

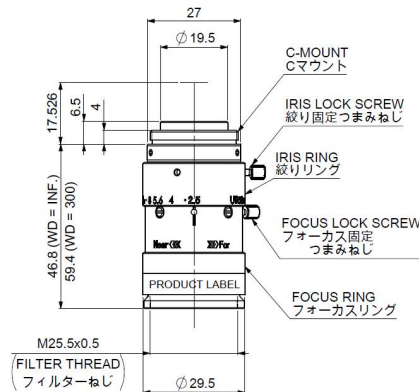

WD=500.0mm Fno2.8

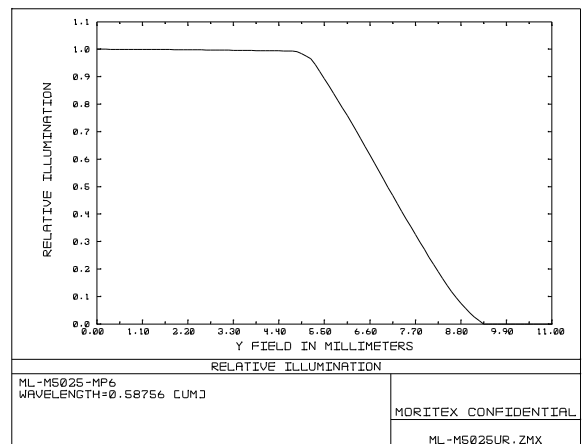
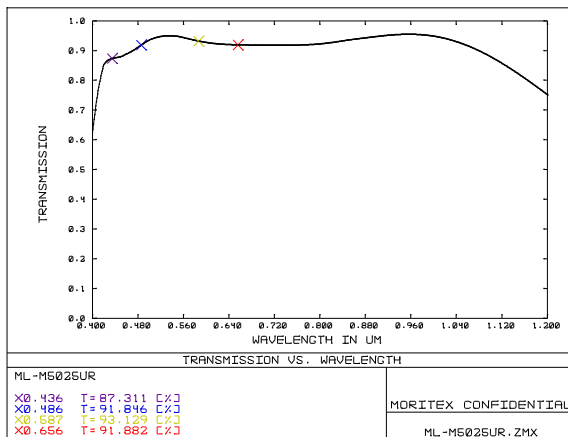
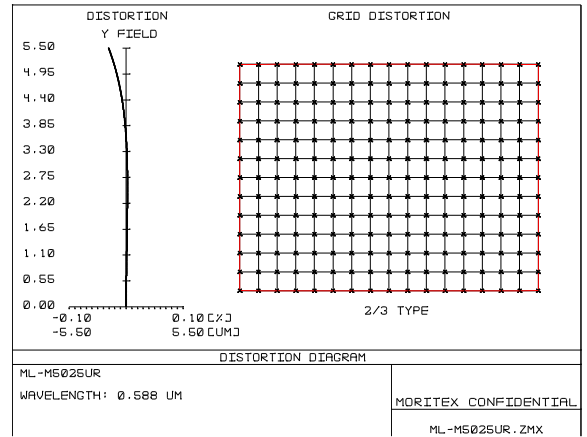
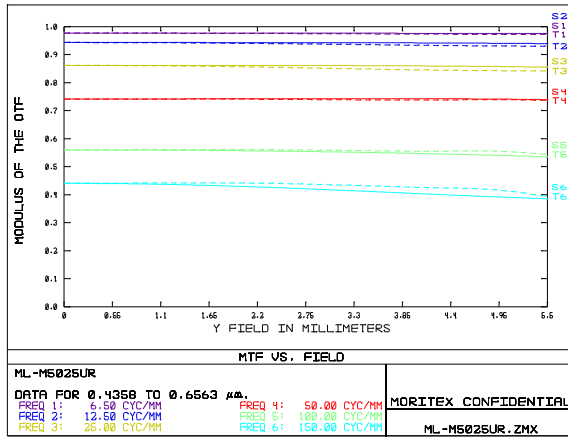

The content is subject to change at any time without notification.

株式会社 **モリテックス** MORITEX Corporation

Technology center Lens design & Development technology

TEL +81 (0)48-218-2536 moritex.mvs@moritex.com

FAX +81 (0)48-462-6713 www.moritex.com



WD=300.0mm Fno2.8

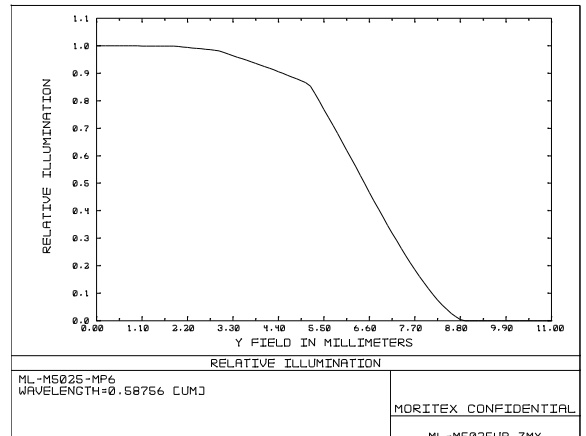
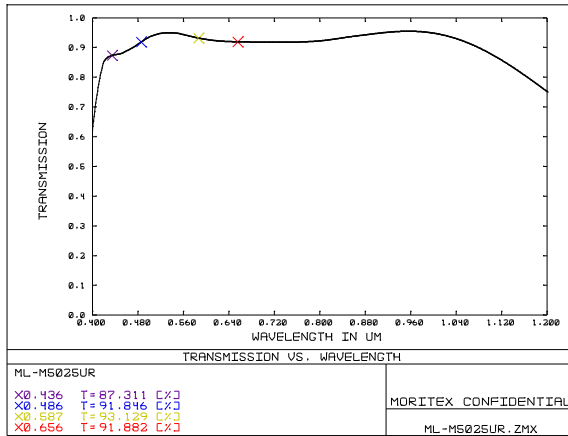
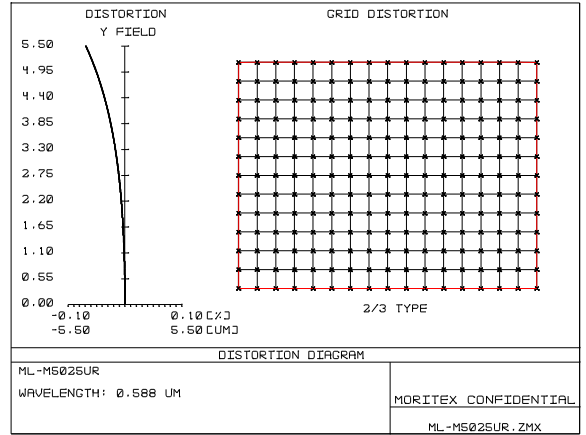
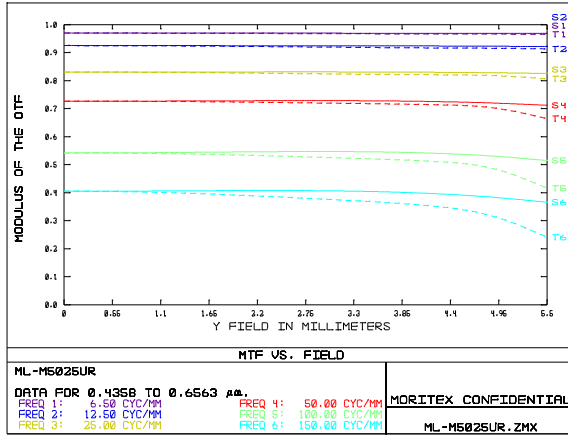

The content is subject to change at any time without notification.

株式会社 モリテックス MORITEX Corporation

Technology center Lens design & Development technology
 TEL +81 (0)48-218-2536 moritex.mvs@moritex.com
 FAX +81 (0)48-462-6713 www.moritex.com

