

Skin Sensors

Analyzing the Skin Condition

Skin sensors are important tools in esthetic skin counseling since they give fast, relevant results for the key factors determining the actual skin condition. Evaluating skin moisture, sebum, and elasticity in seconds give the basic information needed to select the appropriate skin care products without major expense or time.

MORITEX and SCHOTT offer various sensors combining the measurement of the different skin conditions required. Common features of all sensor variations are battery-operated power supply and thus portability.



Applications

Moisture (Hydration, Skin Surface Moisture)

A key concern in esthetic counseling is the determination of moisture in the corneal layer. Sufficient moisture makes the skin appear smooth, soft and supple. A lack of moisture can cause the skin to look dull and cracked, appearing older.

Surface skin moisture measurement is performed by a capacitive sensor. The higher the capacitance of the skin, the higher the resulting score and the more hydrated the skin is at the point of measurement.

Sebum (Oil, Skin Surface Lipid)

Sebum is of mixture of fatty acids, triglycerides, proteins, and other molecules produced by the sebaceous glands of the dermis. Sealing moisture in the corneal layer and preventing evaporation, sebum keeps hair and skin smooth and flexible. Excessive sebum production can cause clogged pores possibly resulting in blemishes.

Sebum can be determined optically by a photometric sensor being placed directly onto the skin. Sebum increases the amount of light reflected from the skin which is collected by the sensor giving a relative value.

Elasticity (Firmness)

Skin elasticity is determined by the elastin (elasticity) and collagen fibers (firmness) of the dermis. Due to aging and external factors, the elasticity of the skin deteriorates over time, leaving the skin appearing dull and saggy.

The elasticity sensor applies an unique measurement technique where a tiny sensor tip oscillates at a particular frequency and, when applied to the skin, will exhibit a change in the frequency reflecting the firmness of the skin. The greater the change in frequency, the more elastic the skin and higher the score.

Measurement principles

Sensor head of Triplesense with all 3 sensors

1. Capacitive Moisture Sensor
2. Photodiode Optical Sebum Sensor
3. Elasticity Oscillating Probe

1. Moisture

Measurement of skin surface moisture is based on a capacitive sensor measurement. The electrical conductivity of the corneal layer depends on its moisture content, represented by different dielectric constant ϵ values. The higher the water content, the higher the sensor reading for moisture.

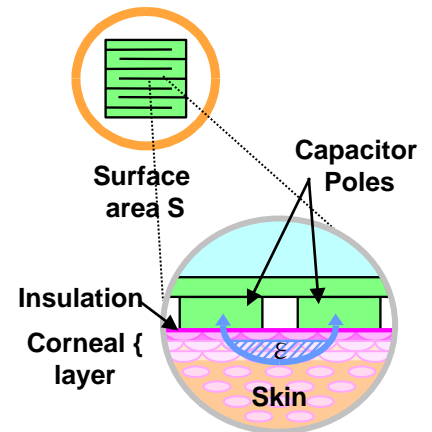
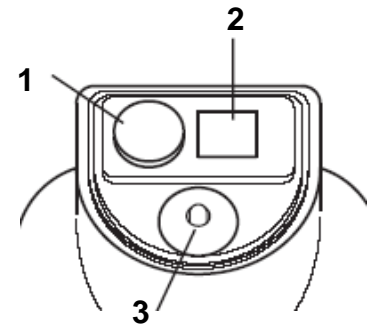

2. Sebum

The patent-pending optical sebum measurement is taken using LED light which is transmitted through an optical system to a glass window in contact with the skin. The amount of sebum between the window and the skin will affect the amount of light that is reflected off the skin and thus the amount of light that reaches the photodiode sensor. The more sebum on the skin surface, the less light that is reflected back to the sensor and higher the resulting value.

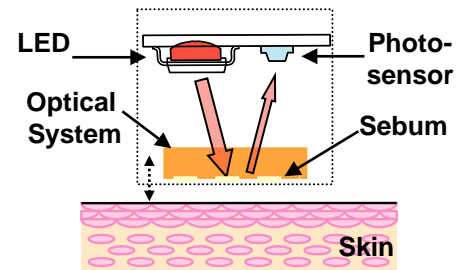

3. Elasticity

The elasticity measurement is achieved utilizing a vibrational sensor. The sensor vibrates at a defined oscillation frequency and when the tip is placed in contact with the skin, there is a change in the frequency. The results depend on the measured attenuation of the original frequency. The greater the change in frequency, the greater the elasticity of the tissue.

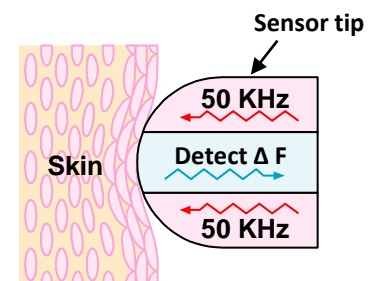
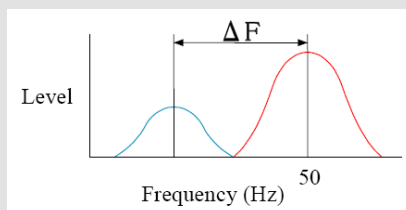

Triplesense / Dual Sensor

Dual Sensor

In addition to moisture, this sensor evaluates the amount of sebum on the particular area of the skin. This allows the user to check the balance of both parameters and determine the resulting skin type (oily, oily-dry, dry, or normal). A relative measurement value is displayed for both measurements along with an age-based ranking.

Triplesense

To further expand upon the parameters measured by the Dual Sensor, elasticity is analyzed in addition to the moisture and sebum. Since elasticity is a key indicator of aging skin, the Triplesense is ideal for anti-aging skin care counseling.

Both the Dual Sensor and Triplesense measure the sebum using optical technology without the use of disposable tapes.

Optional: USB Station (See next page)

Specifications

Measurements	Moisture (Electrical Conductivity):	0 - 99
	Sebum (Optical):	0 - 99
	Elasticity* (Ultrasound):	0 - 99
	(*Triplesense only)	
Display	Multi-Character Black and White LCD Display	
Power Supply	Battery Operated (Alkaline preferred) 2 x Type AAA (LR6)	
Power consumption	250 mWatt	
Dimensions:	63 x 54.6 x 157.3 mm (W x H x L) (See drawing)	
Weight	115 g (without batteries)	
Operating Conditions	Temperature:	15° C - 35° C
	Humidity:	0 - 80 %

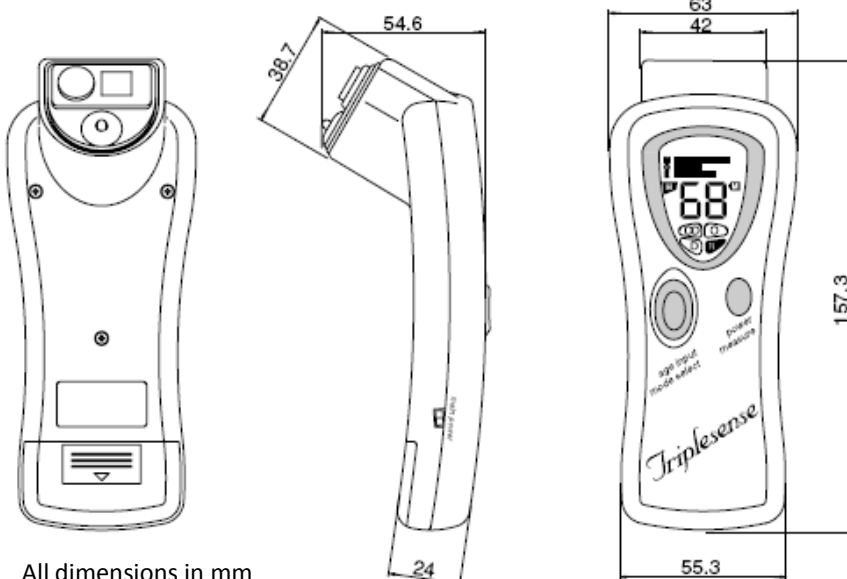

All dimensions in mm

Display of Results

The various measurement results are displayed on a level scale:

M = Moisture

O = Sebum/ Oiliness

E = Elasticity

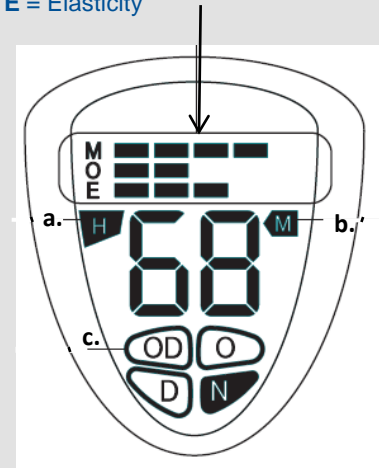

a.

Skin Condition according to age is displayed on a three level scale:

H High

M Middle (avg. range for the age)

L Low

b.

Indicates which information is being displayed by the 2-digit seven segment display in the center:

M Moisture

O Sebum/ Oiliness

E Elasticity

c.

The measured moisture and sebum balance of the skin is displayed as one of four skin types. The skin type is indicated as multi-component letters:

N Normal skin:

Balanced hydration & oil levels

O Oily Skin:

Hydrated, but excessive oil

D Dry skin:

Not hydrated, but average oil

OD Oily & Dry skin:

Low hydration, excessive oil

MoistSense

Basic moisture sensor in a slim, pen-shaped housing. Relative moisture values corresponding to a scoring scale from 0 to 99 are displayed on a digital readout.

Specification

Measurements	Moisture (Electrical Conductivity): 0 – 99
Display	Digital LCD Display, 2-Digit Numerica and Indicator Bars
Power Supply	Battery operated (Alkaline preferred) 2 x Type AAA (LR6) (included)
Power consumption	30 mWatt
Dimensions:	31 x 18 x 156 mm (W x H x L)
Weight	60 g (including batteries)
Operational Conditions	Temperature 15 ° C ... 35 ° C, Rel. Humidity 0 ... 80%



USB-Station (Option for Dual Sensor and Triplesense)

The USB Station enables the direct transfer of measurement data onto a PC or Notebook via USB. The enclosed viewer software allows management of measurement results on the screen and storage of data for future reference.

System requirements

Operating System:	Windows 98/ME, 2000, XP, Win 7 under development
Hard Disk Space:	< 10 MB
CD-ROM Drive:	Required for Installation
Monitor Resolution:	1024 * 768 pixels (Recommended)
USB-Interface:	2.0 Compatible
USB-Cable	USB/USB Mini (Included)



USB-Station

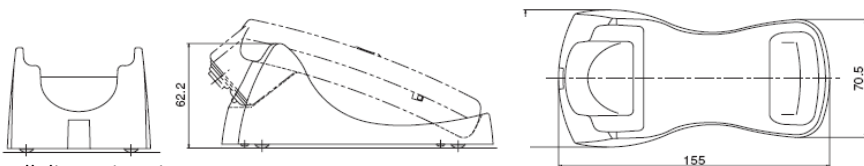

All dimensions in mm



Viewer Software for USB-Station